Color Television

Operating Instructions

Panasonic®



CT-32S20

Read these instructions completely before operating this set.
Contents subject to change without notice or obligation.

Copyright 1995 by Matsushita Electric Corporation of America.
All rights reserved. Unauthorized copying and distribution is a violation of law.

Printed in USA
TQB2AA0060

Safety Instructions

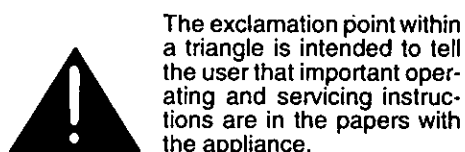
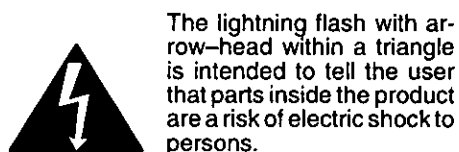
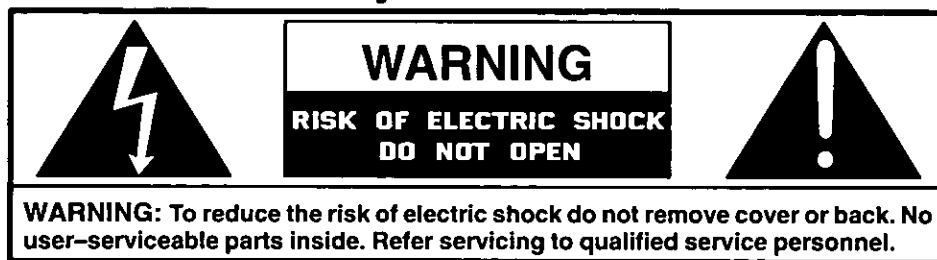

Note To CATV System Installer: This reminder is provided to call the CATV system installer's attention to Article 820-40 of the NEC that provides guidelines for proper grounding and, in particular, specifies that the cable ground shall be connected to the grounding system of the building, as close to the point of cable entry as practical.

Safety Instructions For Television Receivers

1. Read and apply the operating instructions provided with your television receiver.
2. Read all of the instructions given here and retain them for later use.
3. Unplug this television receiver from the wall outlet before cleaning. Do not use liquid or aerosol cleaners. Use a damp cloth for cleaning.
4. Do not use attachments not recommended by the television receiver manufacturer as they may cause hazards.
5. Do not use this television receiver near water. For example: Avoid placing it near a bathtub, washbowl, kitchen sink, or laundry tub, in a wet basement, or near a swimming pool, etc.
6. Do not place this television receiver on an unstable cart, stand, or table. The television receiver may fall, causing serious injury to a child or adult, and serious damage to the appliance. Use only with a cart or stand recommended by the manufacturer, or sold with the television receiver. Wall or shelf mounting should follow the manufacturer's instructions, and should use a mounting kit approved by the manufacturer.
- 6A. An appliance and cart combination should be moved with care. Quick stops, excessive force, and uneven surfaces may cause the appliance and cart combination to overturn.
7. Slots and openings in the cabinet and the back or bottom are provided for ventilation, and to insure reliable operation of the television receiver and to protect it from overheating. These openings must not be blocked or covered. The openings should never be blocked by placing the television receiver on a bed, sofa, rug or other similar surface. This television receiver should never be placed near or over a radiator or heat register. This television receiver should not be placed in a built-in installation such as a bookcase unless proper ventilation is provided.
8. Operate only from the type of power source indicated on the marking label. If you are not sure of the type of power supplied to your home consult your television dealer or local power company. For television receivers designed to operate from battery power, refer to the operating instructions.
9. This television receiver is equipped with a polarized alternating-current line plug (a plug having one blade wider than the other). This plug will fit into the power outlet only one way. This is a safety feature. If you are unable to insert the plug fully into the outlet, try reversing the plug. If the plug should still fail to fit, contact your electrician to replace your obsolete outlet. Do not defeat the safety purpose of the polarized plug.
10. Do not allow anything to rest on the power cord. Do not locate this television receiver where the cord will be abused by persons walking on it.
11. Follow all warnings and instructions marked on the television receiver.
12. Do not overload wall outlets and extension cords as this can result in fire or electric shock.
13. Never push objects of any kind into this television receiver through cabinet slots as they may touch dangerous voltage points or short out parts that could result in a fire or electric shock. Never spill liquid of any kind on the television receiver.

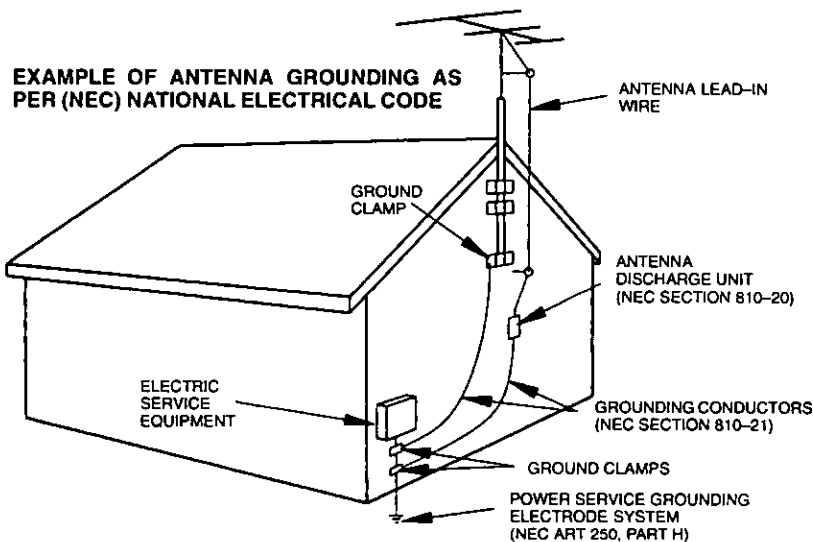

14. If an outside antenna is connected to the television equipment, be sure the antenna system is grounded so as to provide some protection against voltage surges and built up static charges. In the U.S. Section 810 of the National Electrical Code and in Canada Part 1 of the Canadian Electrical Code provides information with respect to proper grounding of the mast and supporting structure, grounding of the lead-in wire to an antenna discharge unit, size of grounding conductors, location of antenna-discharge unit, connection to grounding electrodes, and requirements for the grounding electrode. See Figure.
15. For added protection for this television receiver during a lightning storm, or when it is left unattended and unused for long periods of time, unplug it from the wall outlet and disconnect the antenna. This will prevent damage to the receiver due to lightning and power-line surges.
16. An outside antenna system should not be located in the vicinity of overhead power lines or other electric light or power circuits, or where it can fall into such power lines or circuits. When installing an outside antenna system extreme care should be taken to keep from touching such power lines or circuits as contact with them might be fatal.
17. Unplug this television receiver from the wall outlet, and refer servicing to qualified service personnel under the following conditions:
 - a. When the power cord or plug is damaged or frayed.
 - b. If liquid has been spilled into the television receiver.
 - c. If the television receiver has been exposed to rain or water.
 - d. If the television receiver does not operate normally by following the operating instructions. Adjust only those controls that are covered by the operating instructions as improper adjustment of other controls may result in damage and will often require extensive work by a qualified technician to restore the television receiver to normal operation.
 - e. If the television receiver has been dropped or the cabinet has been damaged.
 - f. When the television receiver exhibits a distinct change in performance – this indicates a need for service.
18. Do not attempt to service this television receiver yourself as opening or removing covers may expose you to dangerous voltage or other hazards. Refer all servicing to qualified service personnel.
19. When replacement parts are required, be sure the service technician has used replacement parts specified by the manufacturer that have the same characteristics as the original part. Unauthorized substitutions may result in fire, electric shock, or other hazards.
20. Upon completion of any service or repairs to this television receiver, ask the service technician to perform routine safety checks to determine that the television is in safe operating condition.
21. **WARNING: To prevent fire or shock hazard, do not expose this appliance to rain or moisture.**
22. **CAUTION: TO PREVENT ELECTRIC SHOCK DO NOT USE THIS (POLARIZED) PLUG WITH AN RECEPTACLE OR OTHER OUTLET UNLESS THE BLADES CAN BE FULLY INSERTED TO PREVENT BLADE EXPOSURE.**

NOTE: This equipment is designed to operate in the U.S.A., Canada and other countries where the broadcasting system and AC house current is exactly the same as in the U.S.A. and Canada.

Important Information Regarding Use of Video Games, Computers, Teletext or Other Fixed Image Displays.

The extended use of fixed image program material can cause a permanent "shadow image" on the picture tube. This background image is viewable on normal programs in the form of a stationary fixed image. This type of irreversible picture tube deterioration can be limited by observing the following steps:

- A. Reduce the brightness/contrast setting to a minimum viewing level.
- B. Do not display the fixed image for extended periods of time.
- C. Turn the power off when not in actual use.

NOTE: The marking or retained image on the picture tube resulting from fixed image use is not an operating defect and as such is not covered by Warranty. This product is not designed to display fixed image patterns for extended periods of time.

Specifications

Power Source:	120V, 60Hz, AC
Channel Capability:	181 channels (See chart) VHF 2~13, UHF 14~69, Cable 125 channels
Video Input Jacks (2):	1V p-p, 75 ohm, phono jack type
Audio Input Jacks (2):	500mV rms, 47K ohm
To Audio AMP Jacks:	0~2.0V rms 4.7K ohm
S-VHS Input Jack:	S-Video (Y-C) Connector
Picture in Picture:	One Tuner
Stereo Sound	
Closed Caption Display	

Channel Capability Chart

BAND	USA/CAN
VHF	12
UHF	56
CABLE (Mid-Band)	15
CABLE (Super Band)	14
CABLE (Hyper Band)	28
CABLE (Ultra Band)	56
TOTAL CHANNELS	181

Specifications are subject to change without notice or obligation.

Introduction

Congratulations on Your New Purchase

Your new video component features an all solid state chassis which is designed to give you many years of enjoyment. It was thoroughly tested and adjusted at the factory for best performance.

In order for you to take full advantage of your new video component, please read and follow the installation and operating instructions supplied with this product.

Customer's Record

The model and serial number of this product may be found on its back cover. You should note the model and serial number in the space provided and retain this book as a permanent record of your purchase to aid in identification in the event of theft or loss.

Model Number: _____ Serial Number: _____

Table of Contents

<p>Safety Instructions 2</p> <p>Specifications 3</p> <p>Introduction 4</p> <p>Installation 5</p> <p style="padding-left: 20px;">Receiver Location 5</p> <p style="padding-left: 20px;">Optional External Equipment Connections 5</p> <p style="padding-left: 20px;">AC Power Supply Cord 5</p> <p style="padding-left: 20px;">Remote Control Battery Installation 5</p> <p style="padding-left: 20px;">Antenna/Cable Connections 6</p> <p>Standard Antenna and External Video Connection 7</p> <p style="padding-left: 20px;">No Cable Box or VCR 7</p> <p style="padding-left: 20px;">Cable Box 7</p> <p style="padding-left: 20px;">Cable Box and VCR 8</p> <p>Optional Equipment Connection and Operation .. 9</p> <p style="padding-left: 20px;">To Audio AMP Connection (stereo) 9</p> <p style="padding-left: 20px;">Video/Audio Connection 9</p> <p>Location of Controls (Receiver) 10</p> <p>Location of Controls (Remote) 11</p> <p>Remote Quick Reference Key Chart 12</p> <p>Control Operation 14</p> <p style="padding-left: 20px;">Power Button 14</p> <p style="padding-left: 20px;">Volume (Vol) Buttons 14</p> <p style="padding-left: 20px;">Mute Button 14</p> <p style="padding-left: 20px;">Channel (Ch) Buttons 14</p> <p style="padding-left: 20px;">Numeric Keypad 14</p> <p style="padding-left: 20px;">VCR Function Buttons 14</p> <p style="padding-left: 20px;">TV/Video Button 15</p> <p style="padding-left: 20px;">Recall Button 15</p> <p style="padding-left: 20px;">R-Tune (Rapid Tune) Button 15</p> <p style="padding-left: 20px;">Multi Button 15</p> <p style="padding-left: 20px;">PIP (Picture in Picture) Button 16</p> <p style="padding-left: 20px;">Swap Button 16</p> <p style="padding-left: 20px;">Size Button 16</p> <p style="padding-left: 20px;">Freeze Button 17</p> <p style="padding-left: 20px;">Move Button 17</p> <p>Main Menu (Icons) 18</p> <p style="padding-left: 20px;">Trilingual Menu Select 18</p>	<p>Picture Adjustments 19</p> <p style="padding-left: 20px;">Picture Norm 19</p> <p style="padding-left: 20px;">Color 19</p> <p style="padding-left: 20px;">Tint 19</p> <p style="padding-left: 20px;">Brightness 19</p> <p style="padding-left: 20px;">Picture 19</p> <p style="padding-left: 20px;">Sharpness 19</p> <p>Audio Adjustments 20</p> <p style="padding-left: 20px;">Audio Norm 20</p> <p style="padding-left: 20px;">Bass, Treble & Balance Adjustments 20</p> <p style="padding-left: 20px;">Audio Mode (Stereo/SAP/Mono) 21</p> <p style="padding-left: 20px;">AI Sound 21</p> <p style="padding-left: 20px;">TV Speakers 21</p> <p>Lock (Game Guard) 22</p> <p style="padding-left: 20px;">Lock Game Guard 22</p> <p style="padding-left: 20px;">Unlock Game Guard 22</p> <p>Channel Caption (Station Identifier) 23</p> <p>Timer Features 24</p> <p style="padding-left: 20px;">Sleep Timer 24</p> <p style="padding-left: 20px;">Program Timer 24</p> <p>Set-Up Features 25</p> <p style="padding-left: 20px;">Set Time (Clock) 25</p> <p style="padding-left: 20px;">Antenna Tuning Mode 25</p> <p style="padding-left: 20px;">Auto Program 26</p> <p style="padding-left: 20px;">Manual Program 26</p> <p style="padding-left: 20px;">CC (Closed Caption) On Mute 27</p> <p style="padding-left: 20px;">CC (Closed Caption) Mode 27</p> <p style="padding-left: 20px;">Trilingual Menu Sytem 28</p> <p>Programming The Universal Remote Control 29</p> <p>VCR Infrared Codes Index 30</p> <p>Cable Converter Box & CD Player Codes 31</p> <p>Cassette Players and AV Receivers Codes 32</p> <p>Laser Disc/DSS/TV/&DVD Codes 33</p> <p>Care & Cleaning 34</p> <p>Power Loss 34</p> <p>Troubleshooting Chart 35</p>
---	---

Installation

Receiver Location

This unit is intended to be used with an optional stand or entertainment center. Consult your dealer for available options. Locate for comfortable viewing. Avoid placing where sunlight or other bright light (including reflections) will fall on the screen.

Use of some types of fluorescent lighting can reduce remote control transmitter range.

Adequate ventilation is essential to prevent internal component failure. Keep away from areas of excessive heat or moisture.

To insure optimum color purity do not position magnetic equipment (motors, fans, other speakers, etc.) nearby.

Optional External Equipment Connections

The Video/Audio connections between components can be made with shielded video and audio cables. For best performance, video cables should utilize 75 ohm coaxial shielded wire. Cables are available from your dealer or electronic supply house.

Before you purchase any cables, be sure you know what type of output and input connectors your various components require. Also determine the length of cable you'll need.

AC Power Supply Cord

CAUTION: To prevent electric shock, match wide blade of plug to wide slot of ac outlet and fully insert. Do not use this (polarized) plug with a receptacle or other outlet unless the blade can be fully inserted to prevent blade exposure.

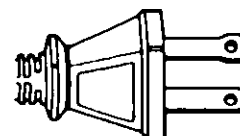

Polarized Plug

Remote Control Battery Installation

Requires two "AA" batteries.

- 1 Turn the Transmitter face down. Remove top cover by pressing down on marking and sliding cover off in the direction indicated.
- 2 Install the batteries as shown in the battery compartment (Polarity (+) or (-) must match the markings in the compartment).
- 3 Replace the cover and slide in reverse until the lock snaps.

Helpful Hint:

For frequent Remote Control users, replace old batteries with Alkaline batteries for longer life.

Note: In order to maximize the life of the batteries, the lighted buttons on the Remote Control can be turned OFF and ON by pressing R-TUNE and RECALL at the same time.

Precaution on Battery Use

Incorrect installation can cause battery leakage and corrosion that will damage the Remote Control Transmitter.

Observe the Following Precautions:

- 1 Batteries should always be replaced as a pair. Always use new batteries when replacing the old set.
- 2 Do not combine a used battery with a new one.
- 3 Do not mix battery types (Example "Zinc Carbon" with "Alkaline").
- 4 Do not attempt to charge, short-circuit, disassemble, heat or burn used batteries.
- 5 Battery replacement is necessary when Remote Control acts sporadically or stops operating the Receiver.

Helpful Hint:

Whenever you remove the batteries to replace them, you may need to reset the Remote Control Infrared Codes. We recommend that you record the codes on page 29, prior to setting up the remote.

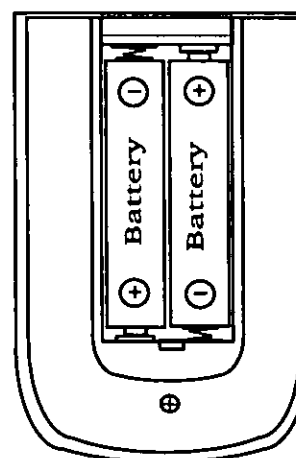

Press Down Here And Slide Cover Back

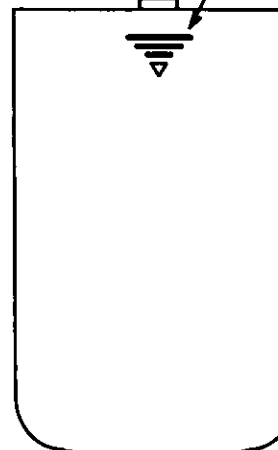

Antenna/Cable Connections

Antenna Connection – For proper reception of VHF/UHF channels an external antenna is required. For best reception an outdoor antenna is recommended. Antenna Mode must be set to TV. (Refer to Antenna Mode section.)

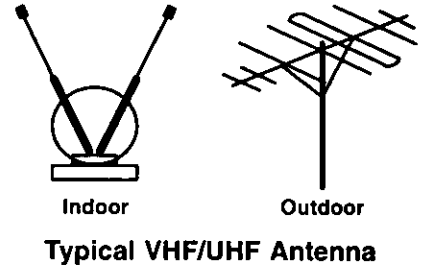

Incoming Cable From Home Antenna (75 Ohm)

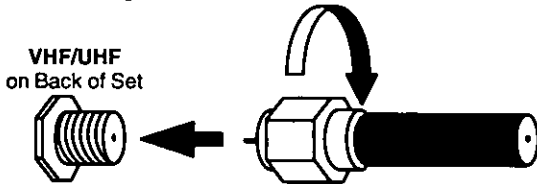

Incoming Cable From Home Antenna (300 Ohm)

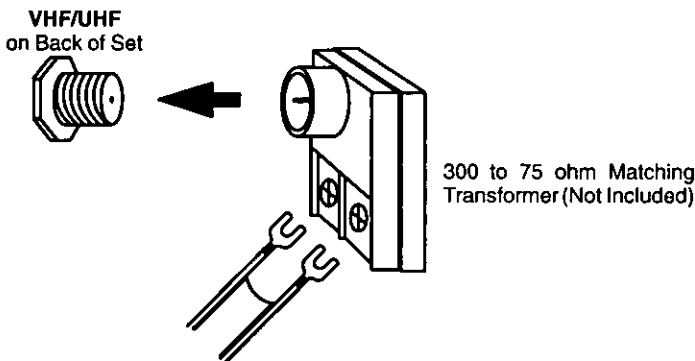

Cable Connection – For reception of cable channels (01–125) connect the cable supplied by your local Cable company. Antenna Mode must be set to CABLE. (Refer to Antenna Mode section.)

Incoming 75 Ohm Cable (From Cable Company)

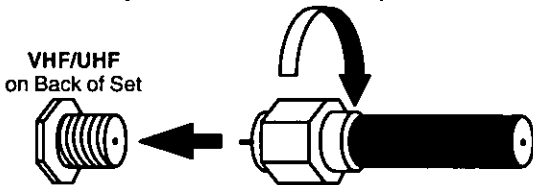

NOTE: Certain cable systems offset some channels to reduce interference or have Premium (scrambled) channels. A Cable Converter box is required for proper reception. Check with your local Cable company for its compatibility requirements.

Other Video Equipment

VCRs, Video Disc Players, Computers, TV games and Teletext equipment can also be connected to the antenna input connection.

Standard Antenna and External Video Connection

The following illustrations show the standard antenna and video connections which can be used for most situations.

Note: This Receiver has the "PICTURE IN PICTURE" feature. This allows you to watch two (2) live broadcasts at the same time as long as an external video source is connected.

Standard Antenna Connection (No Cable Box or VCR)

Use this configuration when connecting the TV directly to the antenna or Cable TV system (without a Cable Box). Be sure to select the correct mode (see the *Set Up Features* section in this Manual for details).

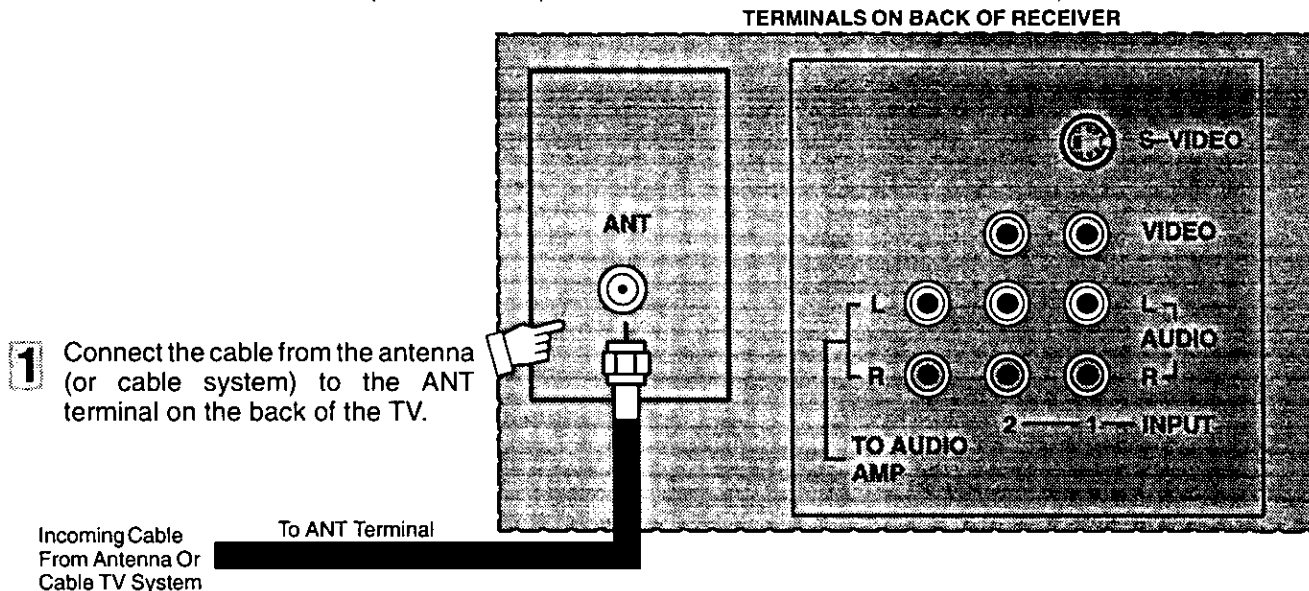

Standard Antenna Connection (Cable Box)

Use this configuration when connecting the TV to the Cable TV system using a Cable Box.

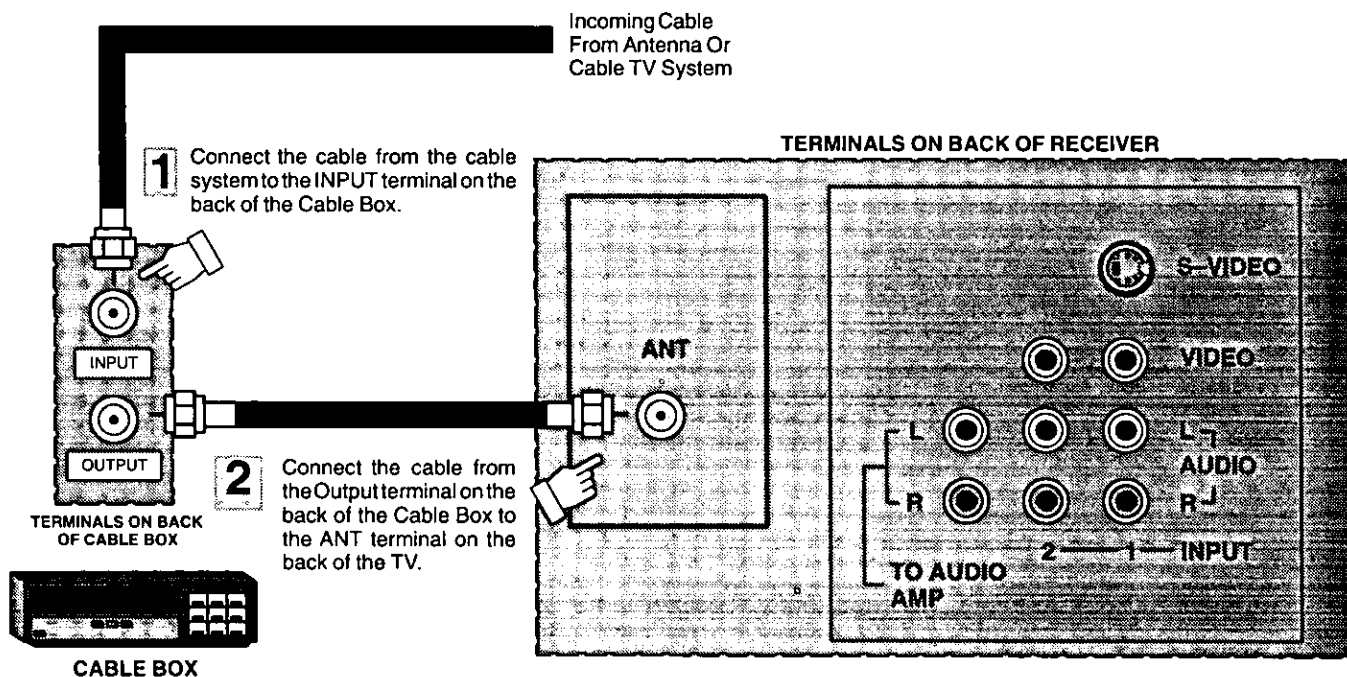

Standard Antenna Connection (Cable Box and VCR)

Use this configuration when connecting the TV to the antenna or Cable TV system and a VCR (with or without a Cable Box). Be sure to select the correct mode (see the *Set Up Features* section in this Manual for details). This configuration is also recommended for the PIP Feature.

S-Video connection is optional and overrides the standard Video connection when connected.

5 Connect the Audio/Video cables as described in the *Audio/Video Connection* section on the next page.

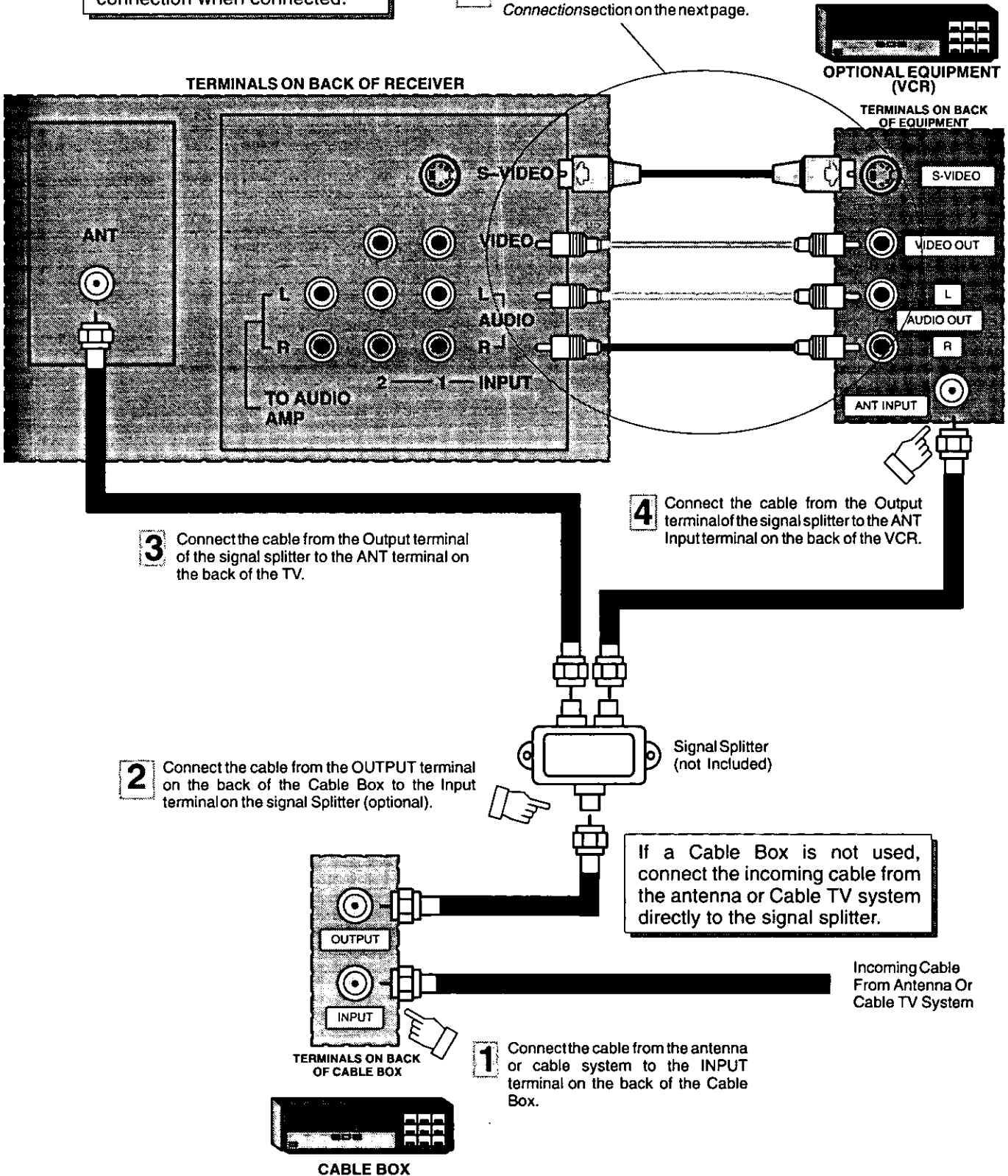

Optional Equipment Connection and Operation

To Audio AMP Connection (Stereo)

Connect to an external audio amp auxiliary input for monitoring sound through a stereo system

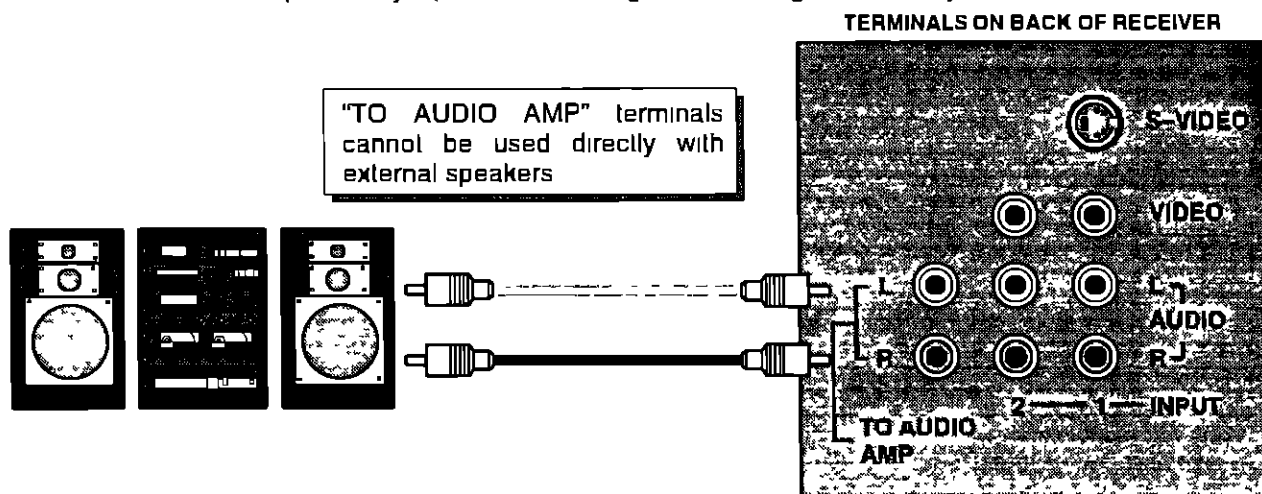

Adjustment – When an audio amp is connected to "TO AUDIO AMP" terminals

- 1 Select INT SPEAKERS "ON" Mode (Refer to the Audio Menu TV Speakers section)
- 2 Set volume of audio amp to near minimum
- 3 Adjust volume of TV to desired listening level
- 4 Adjust volume of audio amp to match the level of TV
- 5 Select INT TV SPEAKERS "OFF&VAO" Mode (Refer to the Audio Menu TV Speakers section)
- 6 Audio bass, treble, balance, volume and mute can now be controlled by the TV Remote Control

NOTE: When Selecting INT TV SPEAKERS "OFF&FAO" Mode, the TV sound output is always at a constant level and cannot be changed (Refer to the Audio Menu TV Speakers section)

Audio/Video Connection

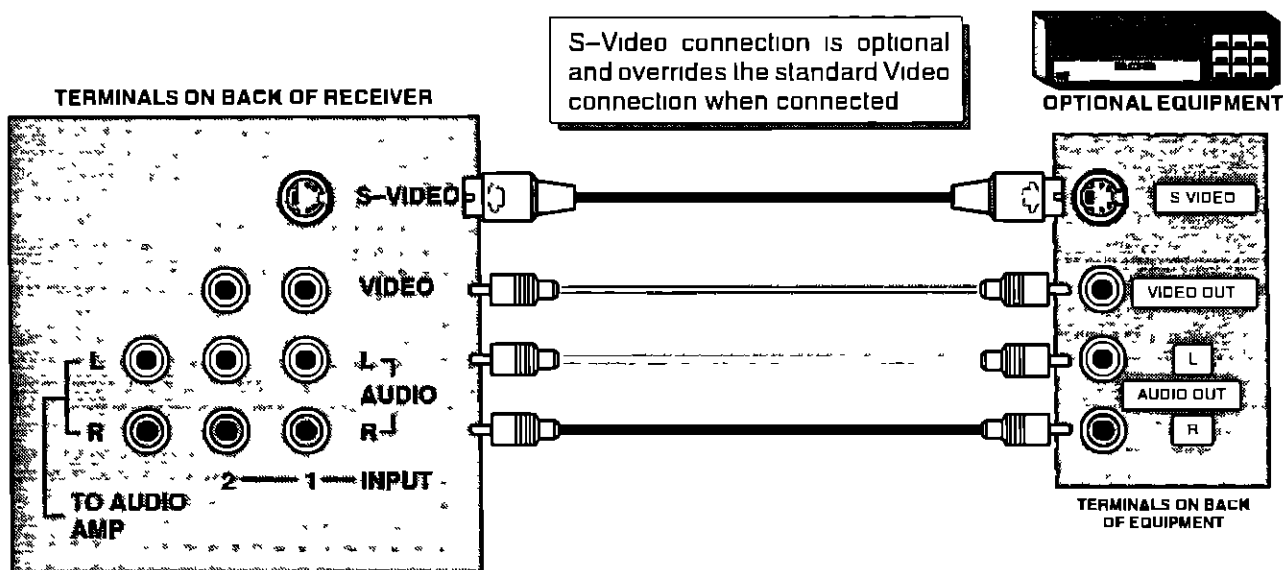

Operation

- 1 Connect optional equipment as shown to INPUT 1 or 2 terminals. If S-Video is to be used, connect S-Video (YC) connector to S-Video terminal of INPUT 1 instead of connecting the standard video cable
- 2 Select the desired Video mode by pressing the TV/VIDEO button
- 3 Operate optional equipment (VCR-VDP) as instructed in Optional Equipment manual

NOTE:

- You must select the same VIDEO Mode that the equipment is connected to
- Connection of optional S-VIDEO jack automatically disconnects the Normal Video Input 1 jack

Location of Controls (Receiver)

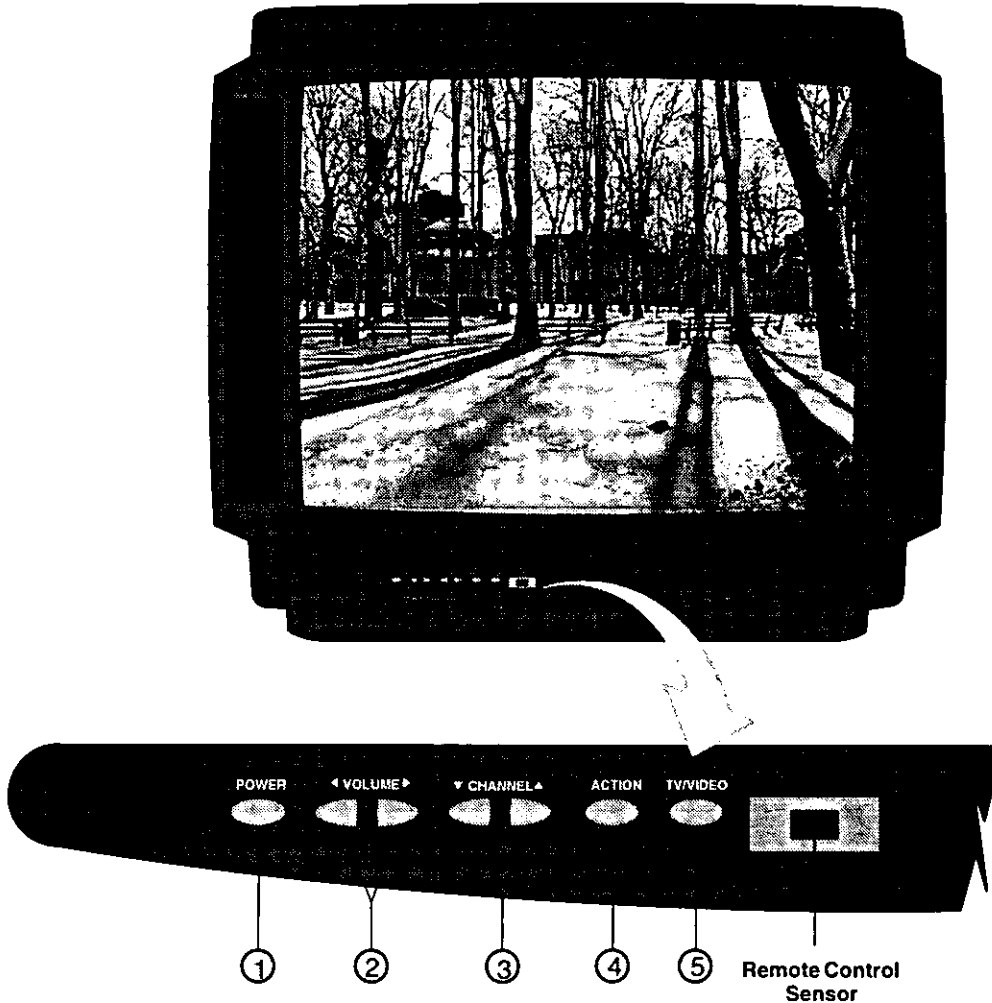

Quick Reference Control Operation (Receiver)

- ① **Power Button** – Press to turn ON or OFF.
- ② **Volume Buttons** – Press to adjust Sound Level. Press to adjust Audio Menus, Video Menus and select operating features when menus are displayed.
- ③ **Channel Buttons** – Press to select programmed channels. Press to highlight desired features when menus are displayed.
- ④ **Action Button** – Press to display Main Menu and access or exit On Screen feature and Adjustment Menus.
- ⑤ **TV/Video Button** – Press to select TV or one of two Video Inputs, for the Main Picture or the PIP frame (when PIP frame is displayed).

Location of Controls for the Illuminated Home Theater Remote Unit

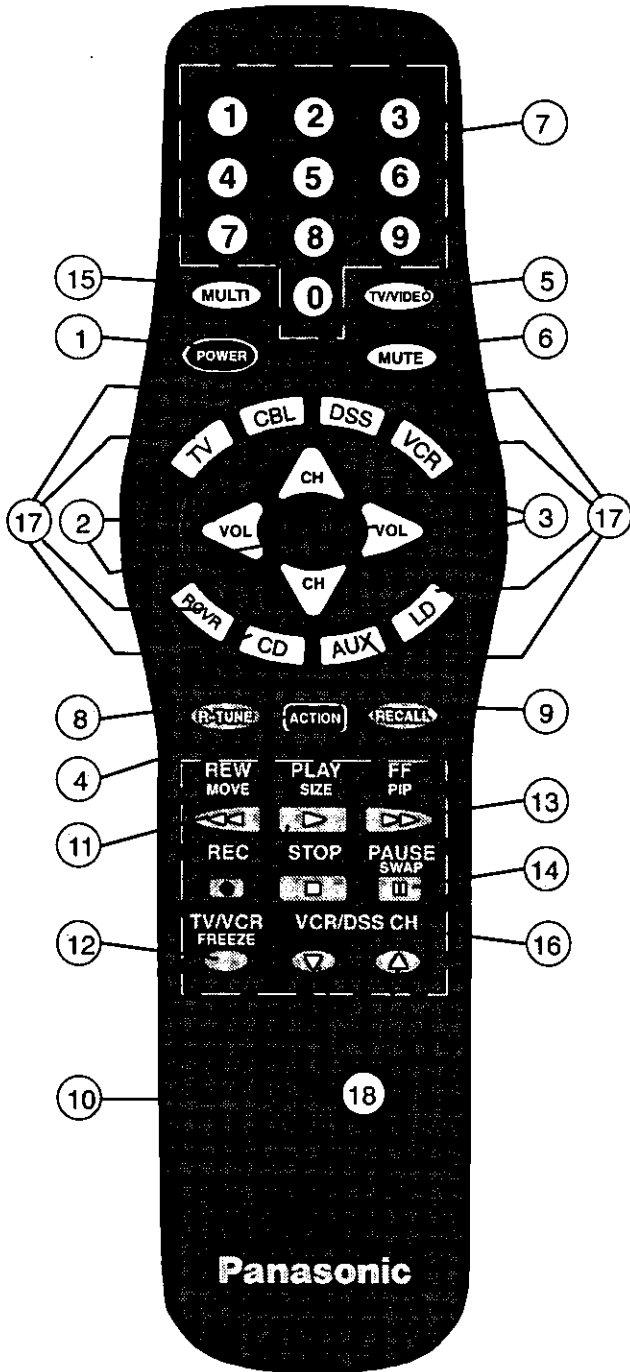

Basic Remote Control Functions

The following is a basic overview of the remote control unit for television operation. Ensure the TV mode is selected by initially pressing **TV**. Please refer to the indicated pages for more information.

- ① **Power Button** – Press to turn the TV ON or OFF.
- ② **Volume Buttons** – Press to adjust TV sound level. Use with Channel buttons to navigate in menus.
- ③ **Channel Buttons** – Press to select channels. Use with Volume buttons to navigate in menus.
- ④ **Action Button** – Press to display Main Menu and access or exit On Screen feature and Adjustment Menus.
- ⑤ **TV/Video Button** – Press to select TV or one of two (2) Video Inputs, for the Main Picture or the PIP frame (when the PIP frame is displayed).
- ⑥ **Mute Button** – Press to mute sound. A second press returns sound.
- ⑦ **Numeric Keypad "0 through 9" Buttons** – Press desired number keys to access any channel.
- ⑧ **R-Tune (Rapid Tune) Button** – Press to switch between the current channel and the channel previously viewed.
- ⑨ **Recall Button** – Press to display Time, status of Sleep Timer, Channel, Video Mode, Channel Caption (Station Identifier) and Audio Mode.
- ⑩ **Size Button** – Press to select size of PIP frame (when the PIP frame is displayed).
- ⑪ **Move Button** – Press to position PIP frame to any corner of the Main Picture (when PIP frame is displayed).
- ⑫ **Freeze Button** – Press to stop action in the Main Picture or PIP frame (when the PIP frame is displayed).
- ⑬ **PIP (Picture In Picture) Button** – Press to display the PIP frame, press again to remove PIP frame.
- ⑭ **Swap Button** – Press to interchange PIP frame with Main Picture (when the PIP frame is displayed).
- ⑮ **Multi Button** – Programmable to operate up to six Remote Function buttons simultaneously.
- ⑯ **VCR Function Buttons** – Programmable to operate many brands of VCR's.
- ⑰ **Mode Selection Buttons** – Selects the operation mode for the remote control.
- ⑱ **VCR/DSS Channel Buttons** – These buttons are used to select VCR or DSS Up/Down channels.

Note: In order to maximize the life of the batteries, the lights can be turned OFF and ON by pressing R-TUNE and RECALL at the same time.











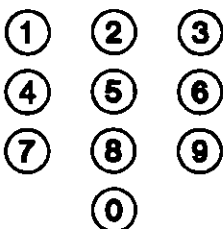











Helpful Hints:

If the selected component does not respond to the remote control, ensure that the proper mode is selected. **First**, press the **Mode Selection Button** that corresponds to that component. For example, after first pressing the TV Mode Button, the remote will remain in the TV mode for any following commands. If a different mode button is pressed while operating the television, the TV mode button must be pressed again to reset the TV mode condition.

NOTE: For more information on the Remote Control, please refer to the Remote Control Quick Reference Functional Key Chart.











Remote Control

Quick Reference Functional Key Chart

KEY	MODE	FUNCTION
	TV VCR CABLE, DSS	Selects Channel Selects Channel Selects Channel
	RECEIVER/AMPLIFIER	 Selects Tuner  Selects CD Player  Selects Tape Cassette Player  VCR 1  VCR 2  VCR 3
	CD PLAYER	Selects Track Number
	LD PLAYER	Selects Track Number
	ALL COMPONENTS	Programmable Button That Can Operate Up To Six Remote Functions At Once
	TV	Selects the TV Input Mode
	ALL COMPONENTS	Turns On and Off Selected Components
	TV, DSS, VCR, LDP CABLE RECEIVER/AMPLIFIER	Mutes TV Audio Mutes Audio Mutes Audio
	TV	TV Mode Selection for Remote Control
	CABLE	Cable Mode Selection for Remote Control
	DSS (DIGITAL SATELLITE SYSTEM)	DSS Mode Selection for Remote Control
	VCR	VCR Mode Selection for Remote Control
	RECEIVER/AMPLIFIER	Receiver/Amplifier Mode Selection for Remote Control
	COMPACT DISC	CD Mode Selection for Remote Control
	CASSETTE PLAYER, DVD	AUX Mode Selection for Remote Control Enables User to Operate a Tape Cassette Player, or Digital Video Disc
	LASER DISC PLAYER	LD Mode Selection for Remote Control
 	TV CABLE DSS LDP CD RECEIVER/AMPLIFIER DVD	Channel Up/Down, Menu Navigation Channel Up/Down DSS Guides and Menu Navigation Skip FF, REW Preset or Tuning Frequency Skip FWD / Skip REW
 	TV CABLE DSS RECEIVER/AMPLIFIER VCR LDP	Volume Up/Down, Menu Navigation Volume Up/Down DSS Guides and Menu Navigation Volume Up/Down TV Volume Up/Down TV Volume Up/Down

Remote Control

Quick Reference Functional Key Chart

KEY	MODE	FUNCTION
	LDP TV CABLE VCR DSS RECEIVER/AMPLIFIER CD TAPE CASSETTE PLAYER	Side A/B Selects Previously Tuned Channel Selects Previously Tuned Channel Selects Previously Tuned Channel Selects Previously Tuned Channel Switches between AM and FM Selects Next Disc Selects Tape Cassette Player A or B
	TV DSS	Activates TV Menus Acts as Menu Button for DSS
	TV DSS VCR LDP	Displays Channel, Time, and Audio Mode Displays Current DSS Settings Displays Current VCR Settings Displays Current LDP Settings
REW MOVE 	TV DSS VCR LDP TAPE CD DVD	PIP Move DSS Guide Rewind Rewind Rewind Selects Previous Track Rewind
PLAY SIZE 	TV DSS VCR LDP TAPE CD DVD	PIP Size Enter/Select Play Play Play (in Normal Direction) Play Play
FF PIP 	TV DSS VCR LDP TAPE CD DVD	PIP On/Off Exit/Clear Fast Forward Fast Forward Fast Forward Selects Next Track Fast Forward
REC 	DSS VCR TAPE CABLE	One Touch Record in DSS Mode Record Record VCR Record
STOP 	DVD VCR LDP TAPE CD CABLE	Stop Stop Stop Stop Stop VCR Stop
PAUSE SWAP 	DVD TV VCR LDP TAPE CD CABLE	Pause PIP Swap Pause Pause Pause Pause VCR Pause
TV/VCR FREEZE 	TV VCR DSS CABLE	PIP Freeze Selects TV/VCR Mode Selects TV/DSS Mode Selects TV/VCR Mode
VCR/DSS CH 	TV VCR DSS CABLE	PIP Channel Up/Down (2 Tuner PIP Models Only) Channel Up/Down Channel Up/Down VCR Up/Down

Control Operation

Helpful Hints:

- Press the TV Mode Selection button to operate TV Remote functions, if necessary



Power Button — Press the POWER button after selecting a mode to turn ON. Press again to turn OFF.

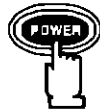

Volume Button — Press the VOLUME (VOL) LEFT or RIGHT button for desired listening level (when On-Screen menus are not displayed).

Located On Remote Control

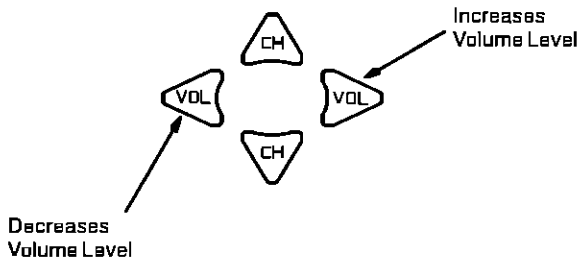

Mute Button — Press the MUTE button to quickly reduce sound level. "MUTE" will appear on screen momentarily. Press again to restore sound.



Helpful Hints:

- Helpful information will display On Screen momentarily when Receiver is first turned on and when the channel is changed.

Note: If "SPEAKER OFF" is displayed On Screen after pressing the VOLUME button, refer to Audio Menu to turn Speakers "ON".

Channel Buttons (UP/DOWN)

Press the CHANNEL (CH) UP/DOWN button to sequentially scan through programmed channels (when On-Screen menus are not displayed).

Note: Press the TV Mode button to operate TV Remote functions, if necessary.

Located On Remote Control

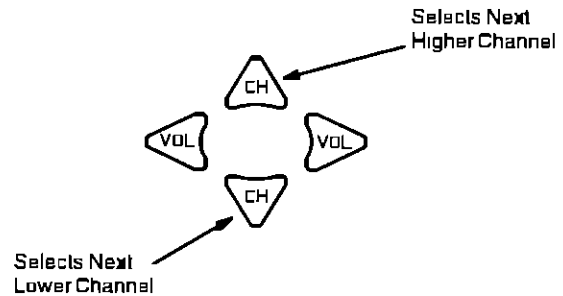

Numeric Keypad (0 through 9 Buttons)

These buttons let you directly access any channel (Example: press 5 for channel 5, press 1, then 3 for channel 13). For channels over 99, press three number buttons.

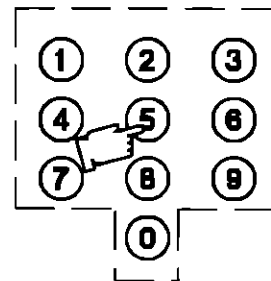

VCR Function Buttons — The VCR function buttons have been designed to operate numerous brands of VCRs. The infrared code must be obtained prior to use (Please refer to Programming the Universal Remote for programming instructions).

Note: Press the VCR Mode Selection button to operate VCR Remote functions.

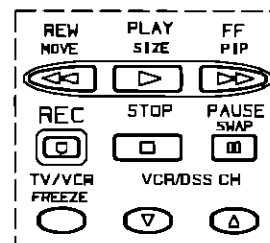

TV/Video Button – Press the TV/VIDEO button to select desired input for Main Picture or PIP frame (when the PIP is displayed)



Signal connected to

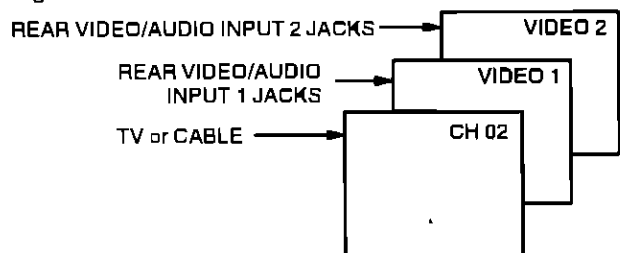

Signal connected to

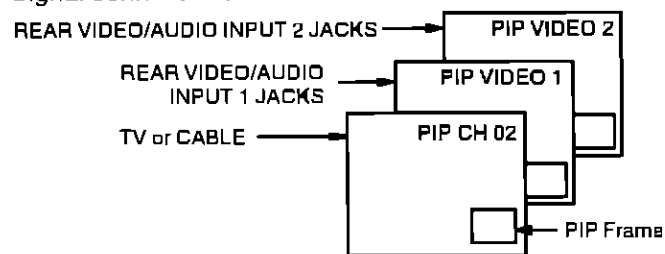

Recall Button – Press the RECALL button to review

- 1 Audio Mode status
- 2 CH number or Video Input selected
- 3 Sleep Timer status
- 4 Clock time
- 5 Channel Caption (Station Identifier)



R-Tune Button – Pressing the R-TUNE (RAPID TUNE) button will switch between the last two channels selected on the numeric keypad

NOTE: When rapidly scanning channels with the CHANNEL UP/DOWN button, pressing the R-TUNE button will switch between the last channel scanned, and initial channel at the start of scanning

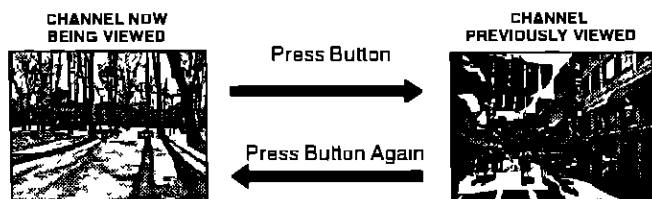

Multi Button

The MULTI button can be programmed to operate up to 6 Remote function buttons at the same time. For Example, TV Power/On, VCR Power/On and Cable box Power/On (selected brands) can be operated at the same time with one press of the MULTI button

Procedure

- 1 First program the Remote for the selected device Infrared access code Confirm that the Remote Control is compatible with the equipment
- 2 Face the Remote Control transmitter away from all equipment remote sensors
- 3 Press and hold the Remote POWER button, then press and hold the ACTION button down at the same time for three seconds (All previous commands are erased)

PRESS AT THE SAME TIME FOR THREE SECONDS

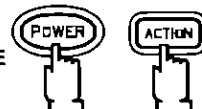

- 4 After three seconds, let go of the POWER and ACTION buttons
- 5 Press the MULTI button (Waiting more than 30 seconds without pressing another button will exit the programming mode)
- 6 Press a maximum of 6 Function buttons on the Remote

Each button you press is equal to one function. If six Remote button functions are entered, all will register in the MULTI button memory in the sequence entered. When finished, press the MULTI button to end the program mode.

The following is an example flow chart of Remote functions that can be programmed into the MULTI button (The VCR Mode button should be programmed before starting procedure see pg. 29).

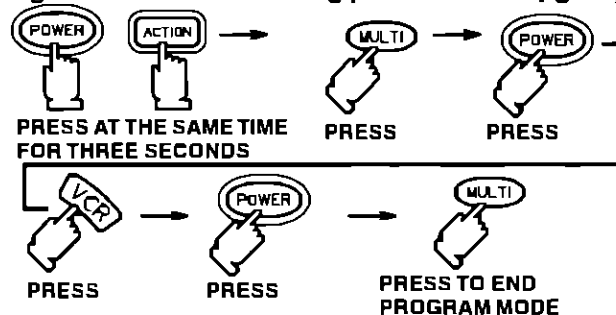

Now you can turn the TV and VCR ON/OFF at the same time with one press of the MULTI button

To delete entered functions – Press and hold the Remote POWER button then press and hold the ACTION button down at the same time for three seconds. Now you can enter from one to six different Remote functions

NOTE

You can also program the MULTI button to perform most individual Remote Control button functions. Buttons which continuously perform a function as long as pressed (Volume Up/Down, Channel Up/Down, etc.) cannot be programmed. Only those buttons which perform a function when initially pressed (Power On/Off, Mute, Direct Channel Entry, etc.) can be programmed.

Helpful Hints:

- Press the TV Mode Selection button to operate TV Remote functions, if necessary



PIP (Picture in Picture) Button – This feature allows the viewer to monitor one channel program while watching another. The monitored source (PIP) must be a different video source (such as a VCR) that is connected to the input jacks.

- S-Video connection will also operate the PIP feature (refer to OPTIONAL S-VIDEO VHS CONNECTION section)
- When the Main Picture is in Video mode with no signal, the PIP will not operate properly

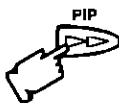

PIP Operation

- Press the TV Mode Selection button to operate the Remote function, if necessary
- Press the PIP button. The PIP frame will appear at the position it was last displayed. The Main Picture channel and PIP channel will display momentarily. Audio will be that of Main Picture.
- Press the PIP button again to cancel PICTURE IN PICTURE feature.

NOTE: For PIP Video source connection, refer to PIP Antenna and External Video connection section.



Swap Button – Press the SWAP button (when the PIP frame is displayed) to interchange what is being viewed on the Main Picture with that of the PIP frame.

- Audio will be that of the Main Picture



Size Button – Press the SIZE button (when the PIP frame is displayed) to choose either the large or small PIP frame.



Small PIP Frame

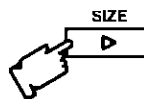

Large PIP Frame

Freeze Button – Press the FREEZE button to stop action in the PIP frame



Move Button – The PIP frame may be located at any corner of the Main Picture by pressing the PIP MOVE button (when the PIP frame is displayed)

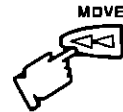

NOTE: Each time MOVE button is pressed (when the PIP frame is displayed), the PIP frame will move (counterclockwise) as illustrated

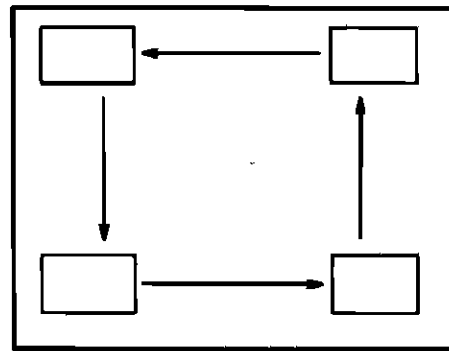

NOTE:

- Pressing the FREEZE button when the PIP frame is not displayed will stop action in the Main Picture and display it on the PIP frame
- Pressing the FREEZE button when PIP frame is displayed will stop action in the PIP frame, press the FREEZE button again to continue action.
- Press the PIP button to delete PIP frame

Main Menu (Icons)

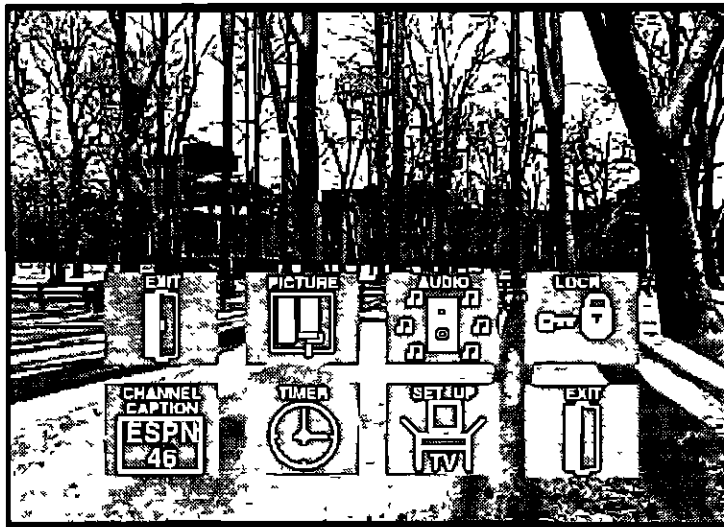

Located On Remote Control

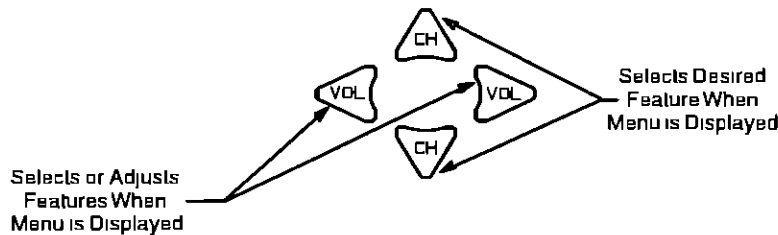

Displays and Exits Menu



- 1 Press the ACTION button to display the Main Menu with Icons
- 2 Press the CH UP or DOWN and the VOL LEFT or RIGHT buttons to select the desired Icon when the Main Menu is displayed (selected Icon will be indicated in Red)
- 3 Press the VOL buttons for left and right movement and the CH buttons for up or down movement
- 4 To exit the Main Menu first select the EXIT Icon, then press the ACTION button

Trilingual Menu Selection

The Language Menu is factory set to ENGLISH Follow these instructions to change the Language Menu to Spanish or French and back to English

- 1 Press the ACTION button to display the Main Menu
- 2 Press the CH DOWN and VOL RIGHT buttons to select the SET-UP Icon
- 3 Press the ACTION button to display the SET-UP Menu
- 4 Press the CH UP or DOWN button to highlight "ENGLISH ESPANOL FRANCAIS"
- 5 Press the VOL LEFT or RIGHT button to highlight ENGLISH, ESPANOL, or FRANCAIS
- 6 Press the ACTION button twice to exit the SET-UP Menu



Picture Adjustments

- Picture Norm
- Color
- Tint
- Brightness
- Picture
- Sharpness

Located On Remote Control

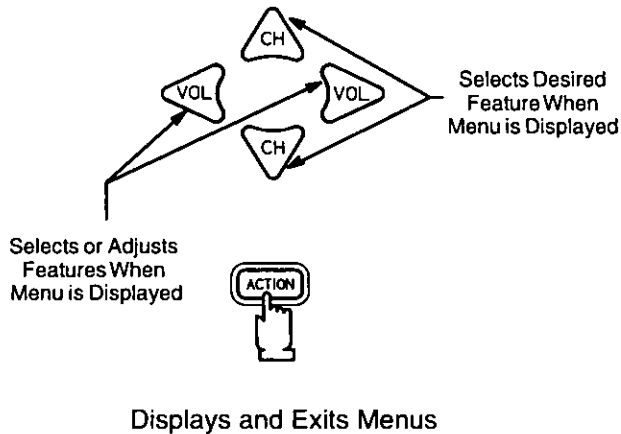

Picture Norm – This feature is used to reset Color, Tint, Brightness, Picture and Sharpness adjustments back to a factory preset level.

1. Press the ACTION button to display the Main Menu.
2. Press the CH UP/DOWN and VOL LEFT/RIGHT buttons to select the Picture Icon.
3. Press the ACTION button to display the Picture Adjustment Menu.

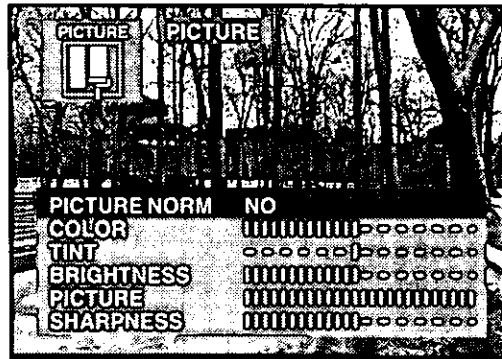

4. Press the CH UP or DOWN button to highlight PICTURE NORM (if necessary).
5. Press the VOL LEFT or RIGHT button to select "SET" to Normalize Color, Tint, Brightness, Picture and Sharpness.
6. Press the ACTION button twice to exit the Picture Adjustment Menu.

Color, Tint, Brightness, Picture & Sharpness Adjustments

1. Press the ACTION button to display the Main Menu.
2. Press the CH UP/DOWN and VOL LEFT/RIGHT buttons to select the Picture Icon.
3. Press the ACTION button to display the Picture Adjustment Menu.

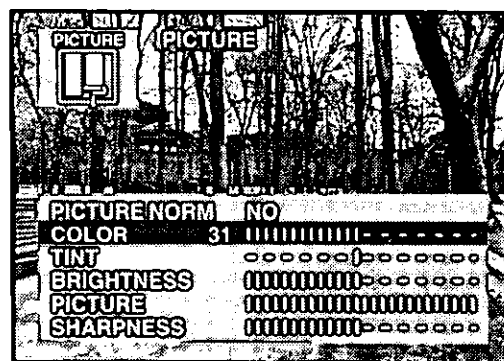

Helpful Hints:

Picture Adjustments:

- COLOR – adjust for desired color intensity.
- TINT – adjust for natural flesh tones.
- BRIGHTNESS – adjust so dark areas of picture just become black for a crisp detail.
- PICTURE – adjust so the white areas of the picture are to your liking.
- SHARPNESS – adjust for best clarity of outline detail.

4. Press the CH UP or DOWN button to highlight the desired Picture Adjustment (Color, Tint, Brightness, Picture or Sharpness).
5. Press the VOL LEFT or RIGHT button to adjust your selection. (The selected Picture Adjustment will be displayed).
6. Repeat steps 4 and 5 for the remaining Picture Adjustments.
7. Press the ACTION button twice to exit the Picture Adjustment Menu.

Audio Adjustment

- Audio Norm
- Bass
- Treble
- Balance
- (Audio) Mode
- AI Sound
- TV Speakers

Located On Remote Control

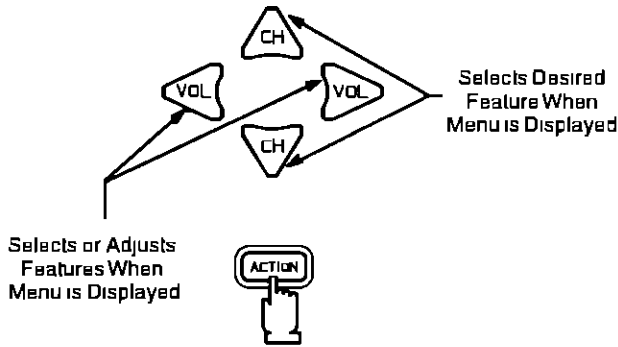

Displays and Exits Menus

Audio Norm – This feature is used to reset BASS, TREBLE and BALANCE back to a factory preset level

- 1 Press the ACTION button to display the Main Menu
- 2 Press the CH UP/DOWN and VOL LEFT/RIGHT buttons to select the Audio Icon
- 3 Press the ACTION button to display the Audio Adjustment Menu



- 4 Press the CH UP or DOWN button to highlight AUDIO NORM
- 5 Press the VOL LEFT or RIGHT button to select "SET" to Normalize Bass, Treble and Balance
- 6 Press the ACTION button twice to exit the Audio Adjustment Menu

Bass, Treble & Balance Adjustment

- 1 Press the ACTION button to display the Main Menu
- 2 Press the CH UP/DOWN and VOL LEFT/RIGHT buttons to select the Audio Icon
- 3 Press the ACTION button to display the Audio Adjustment Menu

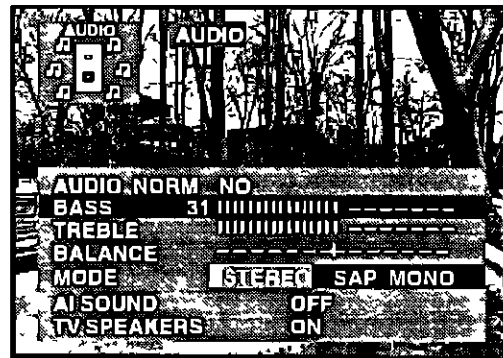

- 4 Press the CH UP or DOWN button to highlight BASS, TREBLE or BALANCE
- 5 Press the VOL LEFT or RIGHT button to adjust for desired audio response
- 6 Repeat steps 4 and 5 for remaining Audio functions
- 7 Press the ACTION button twice to exit the Audio Adjustment Menu

Helpful Hints:

BASS – To increase or decrease the Bass response
TREBLE – To increase or decrease the Treble response
BALANCE – To emphasize the Right and Left Speaker's volume

NOTE: When TV SPEAKERS are in the OFF&FAO mode, the BASS, TREBLE and BALANCE adjustments will indicate FIXED

Audio Adjustment (cont.)

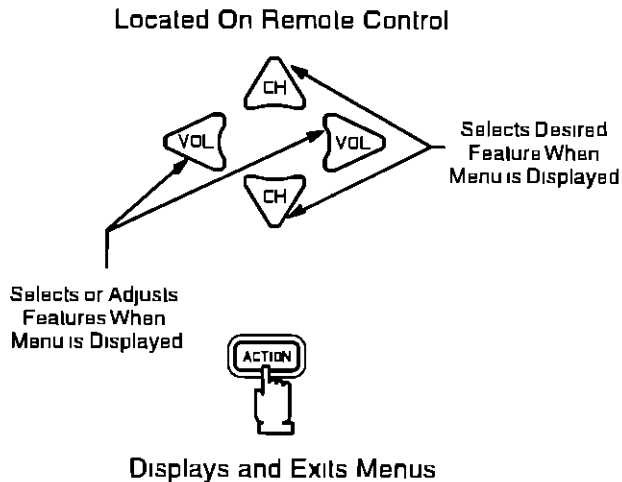

Stereo/SAP/Mono

When Audio is broadcast in Stereo or SAP an ON Screen display will appear on initial "Turn On" and "Channel Change" The available choices will be indicated in red

- 1 Press the ACTION button to display the Main Menu
- 2 Press the CH UP/DOWN and VOL LEFT/RIGHT buttons to select the Audio Icon
- 3 Press the ACTION button to display the Audio Adjustment Menu

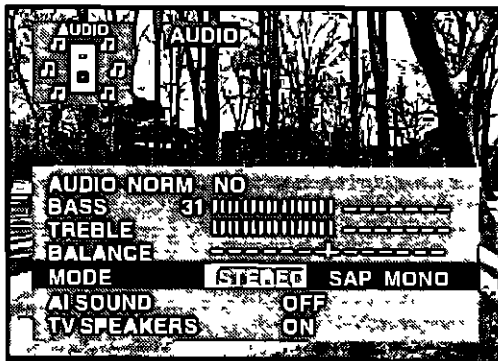

- 4 Press the CH UP or DOWN button to select MODE
- 5 Press the VOL LEFT or RIGHT button to select Stereo, SAP (Second Audio Programming) or Mono
- 6 Press the ACTION button twice to exit the Audio Adjustment Menu

Helpful Hints:

STEREO – Two channel Audio reception
SAP – Second Audio Programming (typically used for bilingual audio)
MONO – Use when stereo signal is weak

AI Sound – This feature regulates the volume between programs and commercial audio to maintain a constant sound output level

- 1 Press the ACTION button to display the Main Menu
- 2 Press the CH UP/DOWN and VOL LEFT/RIGHT buttons to select the Audio Icon
- 3 Press the ACTION button to display the Audio Adjustment Menu

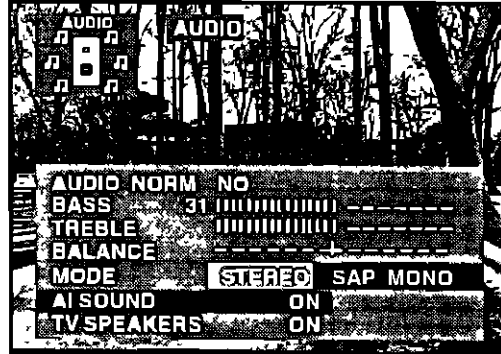

- 4 Press the CH UP or DOWN button to highlight AI SOUND
- 5 Press the VOL LEFT or RIGHT button to select AI SOUND "ON" or "OFF"
- 6 Press the ACTION button twice to exit the Audio Adjustment Menu

TV Speakers – This feature is used to turn the internal speakers "ON" or "OFF" It is used when the Receiver is connected to an External Audio Amplifier (Refer to "To Audio Amp" section for further information)

- 1 Press the ACTION button to display the Main Menu
- 2 Press the CH UP/DOWN and VOL LEFT/RIGHT buttons to select the Audio Icon
- 3 Press the ACTION button to display the Audio Adjustment Menu

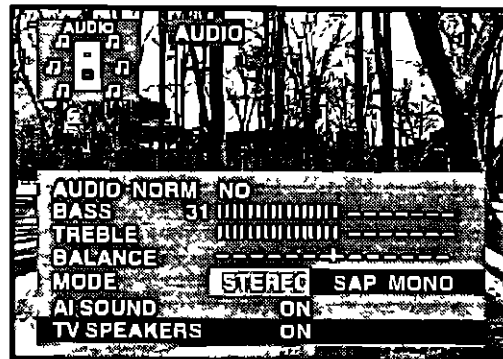

- 4 Press the CH UP or DOWN button to highlight TV SPEAKERS
- 5 Press the VOL LEFT or RIGHT button to select TV Speakers ON, OFF&VAO or OFF&FAO

- ON – TV SPEAKERS operate normally
- OFF&VAO (Variable Audio Output) – TV SPEAKERS off, the sound output varies according to the TV volume, use the TV remote to control the volume, muting, bass, treble and balance of the External Stereo System
- OFF&FAO (Fixed Audio Output) – TV SPEAKERS off, sound output is constant and not adjustable from the TV Use External Audio System's volume control to adjust the sound

- 6 Press the ACTION button twice to exit the Audio Adjustment Menu

Lock

Lock Game Guard

Prevents video games and other video sources from being viewed. Channel 3, 4 and all video inputs are locked out for 12, 24 or 48 hours.

NOTE: Be sure to understand this feature before attempting its use. Use a code that you will easily remember or write down code on a piece of paper.

- 1 Press the ACTION button to display the Main Menu
- 2 Press the CH UP/DOWN and VOL LEFT/RIGHT buttons to select the Lock Icon
- 3 Press the ACTION button to display the Lock (Game Guard) Menu

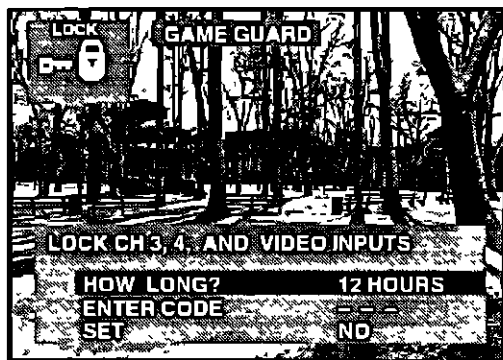

- 4 Press the VOL RIGHT button to select the desired hours (12, 24 or 48) for Game Guard (Lockout) to be activated
- 5 Press the CH DOWN button to select "ENTER CODE" Then enter a 3 digit code with the Remote Control Keyboard
IMPORTANT NOTE. Use a code you can easily remember or write down the code on a piece of paper.
- 6 Press the VOL LEFT or RIGHT button after entering three digit code "Game Guard Locked" will display On Screen



Game Guard Activated

Unlock Game Guard

To unlock the Game Guard feature, repeat steps 1 through 3 from Lock Game Guard. Enter the same 3 digit code previously used in step 5 with Remote Control Keyboard

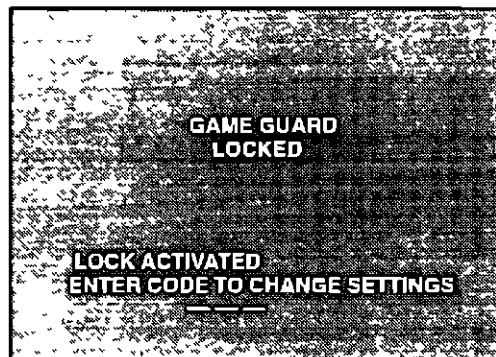

Enter Same 3 Digit Code Previously Used

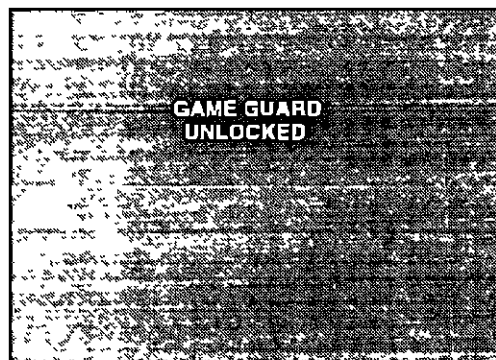

If 3 Digit Code Is The Same

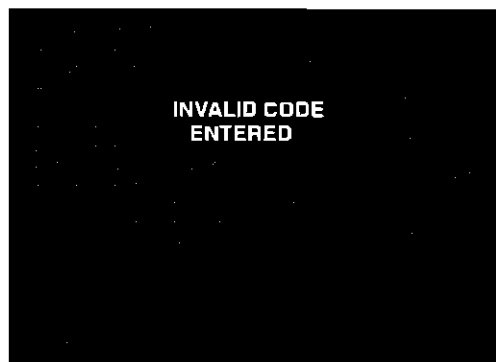

If 3 Digit Code Is Not The Same

Channel Caption

Located On Remote Control

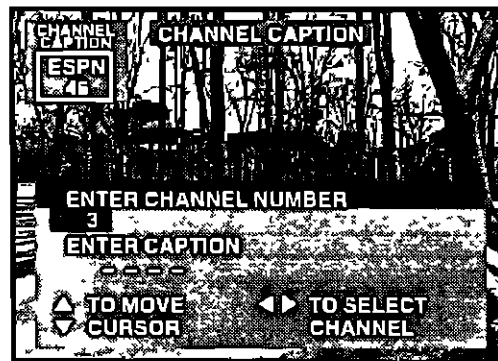
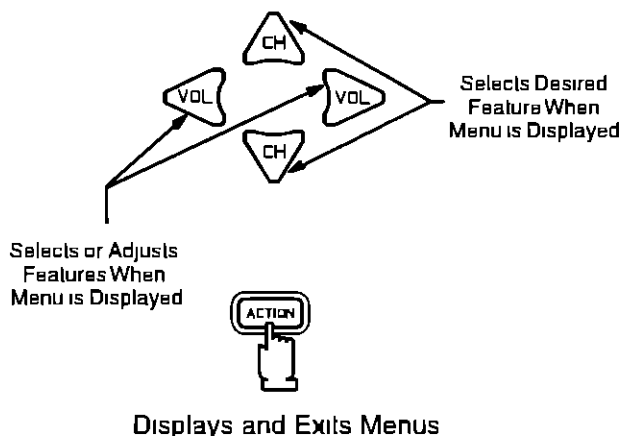

- 4 Press the VOL LEFT or RIGHT button, or use the Remote Control Keyboard, to enter channel number you wish to assign a Station Identifier
- 5 Press the CH DOWN button to select "ENTER CAPTION"

Channel Caption (Station Identifier)

This feature allows you to enter the call names of up to 30 stations into memory (using up to 4 characters for each station) The call name will then display along with the channel number when changing channels or pressing RECALL

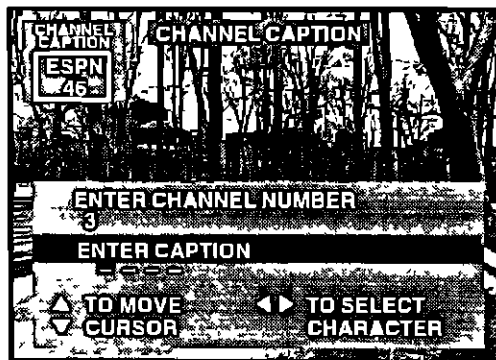

Channel Caption (Station Identifier)

- 1 Press the ACTION button to display the Main Menu
- 2 Press the CH UP/DOWN and VOL LEFT/RIGHT buttons to select the Channel Caption Icon
- 3 Press the ACTION button to display the Channel Caption Menu

- 6 Press the VOL LEFT or RIGHT button to select first character in Station Identifier Then press the CH DOWN button to move cursor to the second position and repeat until the complete Station Identifier is entered (up to 4 characters)
- 7 Press the CH UP or DOWN button to select "ENTER CHANNEL NUMBER" Then repeat steps 4 through 6 to continue adding Channel Station Identifier(s)
- 8 Press the ACTION button twice to exit the Channel Caption Menu

NOTE: To delete a Channel Caption (Station Identifier) from memory all four character positions must display dash mark (-)

Helpful Hints:

When the Maximum amount of station identifiers are entered, "FULL" will be displayed in the characters position

Timer Features

- Sleep Timer
- Program Timer

Special Feature:

Automatic turn "OFF" after 90 minutes

The TV has a special feature that will shut itself **OFF** after 90 minutes when turned **ON** by the program timer unless a function key is pressed during the 90 minutes

This feature is useful so that the TV will not remain **ON** unattended for an extended period of time

Programming the **OFF** timer will also cancel the automatic **OFF** feature

Sleep Timer – This feature is used for automatic turn off in 30, 60 or 90 minutes

NOTE: Display will flash 3, 2 and 1 to indicate the last three remaining minutes prior to turn off. The Recall display will also appear

- 1 Press the ACTION button to display the Main Menu
- 2 Press the CH UP/DOWN and VOL LEFT/RIGHT buttons to select the Timer Icon
- 3 Press the ACTION button to display the Timer Control Menu

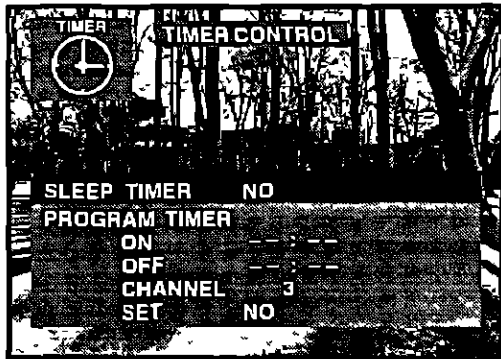

- 4 Press the VOL RIGHT button to select 30, 60 or 90 minutes (Sleep Timer will be activated)
- 5 Press the ACTION button twice to exit the Timer Control Menu

NOTE: To deactivate Sleep Timer repeat steps 1 through 4. In step 4 select "NO" instead of minutes

Helpful Hints:

Press the **RECALL** button to display the remaining minutes for Sleep Timer, the time will display in the bottom left corner

Program Timer – This feature is capable of turning the TV on, tuned to a desired channel and off at a predetermined time (one day or everyday)

NOTE: The clock must be set for this feature to operate (Refer to the Set-Up Menu to set time)

- 1 Press the ACTION button to display the Main Menu
- 2 Press the CH UP/DOWN and VOL LEFT/RIGHT buttons to select the Timer Icon
- 3 Press the ACTION button to display the Timer Control Menu

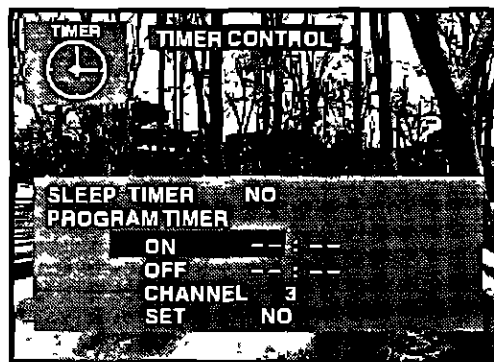

- 4 Press the CH DOWN button to select "ON" (time)
- 5 Press the VOL LEFT or RIGHT button repeatedly to set hours (set AM/PM accordingly)
- 6 Press the CH DOWN button to select the minutes position
- 7 Press the VOL LEFT or RIGHT button repeatedly to set minutes
- 8 Press the CH DOWN button to select "OFF" (time)
- 9 Repeat steps 5 through 7 for setting "OFF" (time)
- 10 Press the CH DOWN button to select "CHANNEL"
- 11 Press the VOL LEFT or RIGHT button or use the Remote Control Keyboard to enter the channel number desired when the set turns "ON"
- 12 Press the CH DOWN button to select "SET"
- 13 Press the VOL RIGHT button to select
 - NO – not activated
 - ONE DAY – activated
 - DAILY – activated

NOTE: To deactivate Program Timer select "NO" in step 13

- 14 Press the ACTION button twice to exit the Timer Control Menu

Helpful Hints:

- If you see "GAME GUARD" in the upper right hand corner, the channel or Video Input you have selected has been locked out
- If the Program Timer "ON" functions while the set is operating, the set will automatically tune to the channel designated in the Timer Program

Set-Up Features

- Set Time
- Antenna (TV or Cable)
- Auto Program
- Manual Program
- CC (Closed Caption) on Mute
- CC (Closed Caption) Mode
- English, Spanish, or Francais

Located On Remote Control

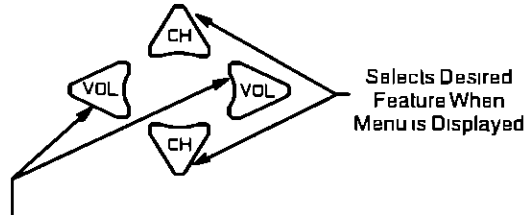

Selects or Adjusts Features When Menu is Displayed



Displays and Exits Menus

Set Time – Clock (when set) will display on screen at initial “Turn On”, after a channel change and when pressing the RECALL button. The time must be set first in order to operate the Program ON/OFF Timer.

- 1 Press the ACTION button to display the Main Menu
- 2 Press the CH UP/DOWN and VOL LEFT/RIGHT buttons to select the Set-Up Icon
- 3 Press the ACTION button to display the Set-Up Menu, Set Time will be highlighted



- 4 Press the VOL LEFT or RIGHT button to set hours (set AM/PM accordingly)
- 5 Press the CH DOWN button to select minutes position
- 6 Press the VOL LEFT or RIGHT button repeatedly to set minutes
- 7 Press the ACTION button twice to exit the Set-Up Menu

ANT (TV or Cable Tuning Mode) The proper Input mode must be selected for the type of signal at the antenna input

- TV mode is used when the Receiver is not connected to a cable TV system, for example when using a VHF/UHF antenna (channels 02 – 69)
- Cable mode is used when the Receiver is connected to a Cable TV system and you are not using a cable company converter box (channels 01 – 125)

- 1 Press the ACTION button to display the Main Menu
- 2 Press the CH UP/DOWN and VOL LEFT/RIGHT buttons to select the Set-Up Icon
- 3 Press the ACTION button to display the Set-Up Menu



- 4 Press the CH DOWN button to highlight ANTENNA
- 5 Press the VOL LEFT or RIGHT button to select TV or CABLE
- 6 Press the ACTION button twice to exit the Set-Up Menu

Set-Up Features (cont.)

Located On Remote Control

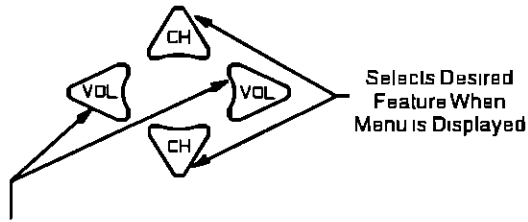

Selects or Adjusts Features When Menu is Displayed



Displays and Exits Menus

Auto Program

This feature allows you to place all channels with a video signal into Channel Scan Memory

- 1 Press the ACTION button to display the Main Menu
- 2 Press the CH UP/DOWN and VOL LEFT/RIGHT buttons to select the Set-Up Icon
- 3 Press the ACTION button to display the Set-Up Menu



- 4 Press the CH DOWN button to highlight AUTO PROGRAM
- 5 Press the VOL LEFT or RIGHT button to start Auto Programming. Channels will automatically advance until all channels have been scanned
- 6 Press the ACTION button twice after completion of Auto Programming to exit the Set-Up Menu

NOTE: Channel numbers with signal present will turn blue which indicates stored in Channel Scan Memory

Manual Program

This feature allows you to select which channels are placed into Channel Scan Memory

- 1 Press the ACTION button to display the Main Menu
- 2 Press the CH UP/DOWN and VOL LEFT/RIGHT buttons to highlight the Set-Up Icon
- 3 Press the ACTION button to display the Set-Up Menu

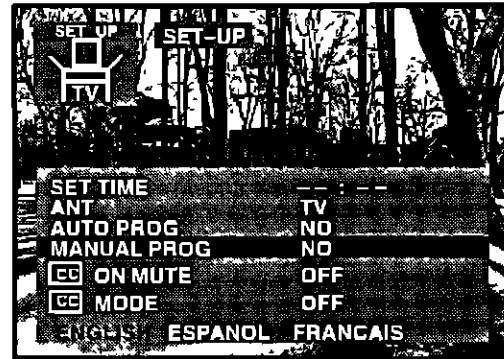

- 4 Press the CH DOWN button to highlight "MANUAL PROG"
- 5 Press the VOL LEFT or RIGHT button to display the Manual Programming Menu

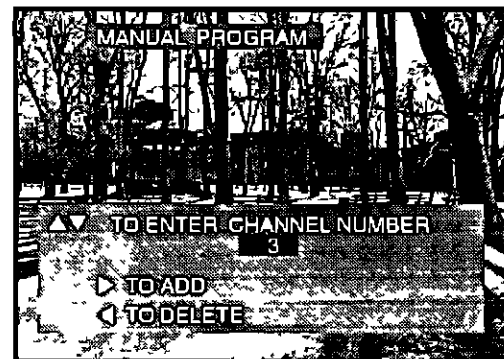

- 6 Use the CH UP or DOWN button or the Remote Keyboard "0 through 9" buttons to select channels
- 7 Press the VOL RIGHT button to add channel(s) to memory (Blue). Press the VOL LEFT button to delete channels from memory (Yellow)
- 8 Repeat steps 6 and 7 to continue adding or deleting channels
- 9 Press the ACTION button twice to exit the Manual Programming Menu

Set-Up Features (cont.)

CC (Closed Caption) with Mute Button

Activates the On Screen Closed Captioning when the MUTE button on the Remote Control is pressed. To deactivate press the MUTE button again.

NOTE: This feature only functions when the Closed Caption Mode is in the "OFF" position. The program being viewed must be broadcast with Closed Caption. (Refer to your local TV guide)

- 1 Press the ACTION button to display the Main Menu
- 2 Press the CH DOWN and VOL RIGHT buttons to select the Set-Up Icon
- 3 Press the ACTION button to display the Set-Up Menu



- 4 Press the CH DOWN button to highlight "CC ON MUTE"
- 5 Press the VOL RIGHT button to select OFF, C1 or C2 Mode

Recommended Set-Up:

- Place CC ON MUTE into the C1 Mode
- Press the CH DOWN button to select "CC MODE"
- Press the VOL RIGHT button to select "OFF"



- 6 Press the ACTION button twice to exit the Set-Up Menu
- 7 Press the MUTE button when the program being viewed is broadcast with Closed Caption to activate. Press again to deactivate.

CC (Closed Caption) Mode

This Receiver has a built in decoder that provides a visual depiction of the audio portion of a television program in the form of written words across the screen (White or Colored letters on a black background). It allows the viewer to read the dialogue of a television program or other information.

- 1 Press the ACTION button to display the Main Menu
- 2 Press the CH UP/DOWN and VOL LEFT/RIGHT buttons to select the Set-Up Icon
- 3 Press the ACTION button to display the Set-Up Menu



- 4 Press the CH DOWN button to select "CC MODE"
- 5 Press the VOL RIGHT button to select OFF, C1, or C2
 - **OFF** – Select to turn Closed Caption off
 - **C1** – For video related information that can be displayed (up to 4 lines of script strategically placed on the television screen so that it does not obstruct relevant parts of the picture). Script can be in any language
 - **C2** – Another mode used for video related information that can be displayed (up to 4 lines of script strategically placed on the television screen so that it does not obstruct relevant parts of the picture)
- 6 Press the ACTION button twice to exit the Set-Up Menu

Helpful Hints:

- Closed Caption information may be transmitted on either or both Caption Modes

Set-Up Features (cont.)



Trilingual Menu System

The Language Menu is factory set to ENGLISH. Follow these instructions to change the Language Menu to Spanish or French and back to English.

- 1 Press the ACTION button to display the Main Menu
- 2 Press the CH DOWN and VOL RIGHT buttons to select the SET-UP icon
- 3 Press the ACTION button to display the SET-UP Menu
- 4 Press the CH UP or DOWN button to highlight "ENGLISH ESPANOL FRANCAIS"
- 5 Press the VOL LEFT or RIGHT button to highlight ENGLISH, ESPANOL, or FRANCAIS
- 6 Press the ACTION button twice to exit the SET-UP Menu

Helpful Hints:

Language Menu does not affect Close Caption or other transmitted text information

Located On Remote Control

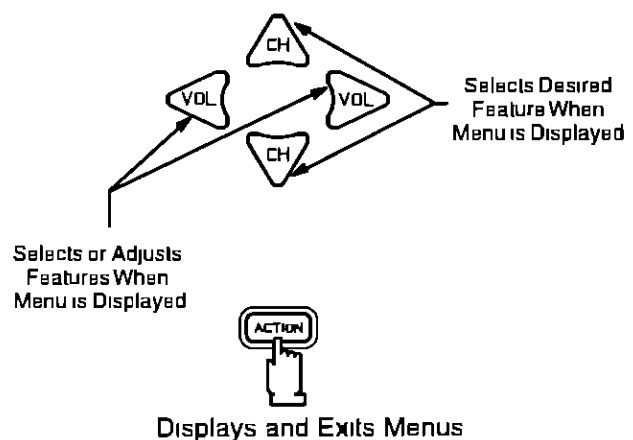



Programming The Illuminated Remote Control Using Access Codes

The remote control can be preset for other manufacturers, by utilizing the **MODE SELECTION BUTTONS** for **CABLE, DSS, VCR, RCVR** (a Receiver or Amplifier), **CD, LD**, and **AUX** (for **Cassette Players** or a **DVD**)

Procedure

Procedure for setting up the remote using the numerical buttons.

- Determine brand of device
 - Identify code(s) associated with the brand in the infrared code index (located in this manual on pages 30 thru 33) Record all possible codes
 - Confirm the device is plugged in and operating properly
- 1** Press and hold the  button, then the  button so that both are pressed at the same time for, at least 5 seconds. All of the Mode buttons will flash.
 - 2** Press the desired Mode button. That Mode button will illuminate steadily. All other buttons will go out.
 - 3** Enter the three digit code, by using the Remote Control Keyboard "0 through 9" buttons
- If you entered a valid code, the mode key will blink twice then go out

Now your remote is set for this code.

- 4** Press  to test your device.

NOTE: Some brands have multiple codes. Repeat the procedure using each listed code until the device responds correctly.

- If you enter an unlisted code, or if you do not complete your entry within 30 seconds, the mode key illumination will go out and the settings will not change

Code From Index Sheet

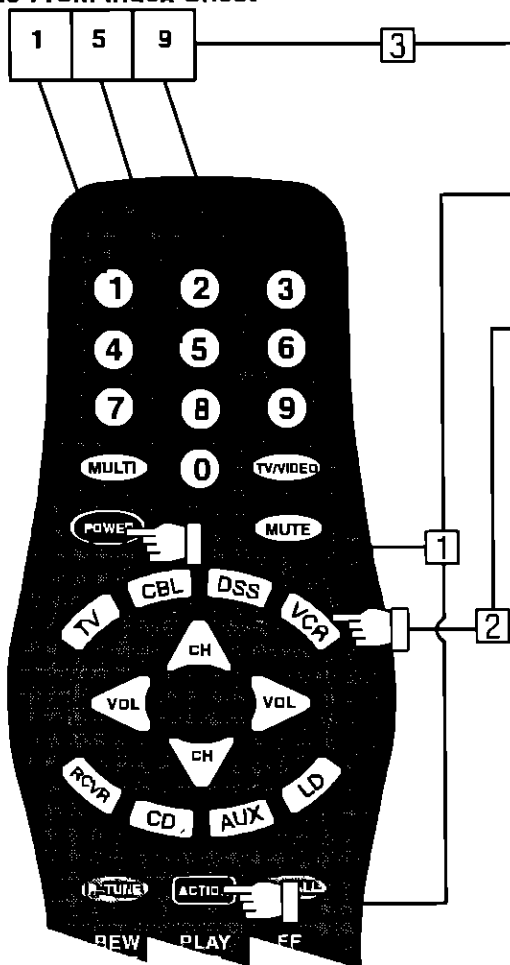

Infrared Remote Codes for Specific Components

Helpful Hint: Write down the code numbers for your components in the space provided below. This will serve as a handy reference whenever you need to reprogram your remote control.

CABLE Cable TV Converter Box	<input type="text"/> <input type="text"/> <input type="text"/>	VCR Video Cassette Recorder	<input type="text"/> <input type="text"/> <input type="text"/>	CD Compact Disc Player	<input type="text"/> <input type="text"/> <input type="text"/>
DSS Digital Satellite System	<input type="text"/> <input type="text"/> <input type="text"/>	RCVR Receiver or Amplifier	<input type="text"/> <input type="text"/> <input type="text"/>	LD Laser Disc Player	<input type="text"/> <input type="text"/> <input type="text"/>
_____ Other Component	<input type="text"/> <input type="text"/> <input type="text"/>	_____ Other Component	<input type="text"/> <input type="text"/> <input type="text"/>	_____ Other Component	<input type="text"/> <input type="text"/> <input type="text"/>
_____ Other Component	<input type="text"/> <input type="text"/> <input type="text"/>	_____ Other Component	<input type="text"/> <input type="text"/> <input type="text"/>	_____ Other Component	<input type="text"/> <input type="text"/> <input type="text"/>

VCR Infrared Codes Index

The Universal Infrared Remote Control is capable of operating many brands of VCRs. Refer to page 29 for programming procedures.

NOTE: The Universal Remote Control memory is limited. Some models of VCRs may not operate. The Universal Remote Control is not designed to control all features that are available in all models.

NOTE: After entering the proper infrared code, press the Remote VCR Selection Mode button (*). To operate the Remote VCR function buttons, refer to pages 12 and 13 for Remote Control Key Functions.

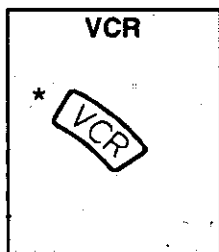

Code Index For VCRs			
VCR Brand	Code(s)	VCR Brand	Code(s)
Adventura	000	MTC	000, 240
Aiko	278	Multitech	000, 072
Aiwa	000	NEC	038, 041, 067
Akai	041, 061	Nikko	037
American High	035	Noblex	240
Asha	240	Olympus	035
Audiovox	037	Optimus	037, 048, 104
Beaumarck	240	Panasonic	035, 162, 225, 454
Bell & Howell	104	Penney	035, 037, 038, 042
Broksonic	121, 184		240
Calix	037	Pentax	042
Canon	035	Philco	035
Carver	081	Philips	035, 081
CCE	072, 278	Pilot	037
Citizen	037, 278	Pioneer	067
Colt	072	Protec	072
Craig	037, 047, 072, 240	Pulsar	039
Curtis Mathes	035, 041, 060	Quarter	046
Cybernex	240	Quartz	046
Daewoo	045, 278	Quasar	035
Dynatech	000	Radio Shack	000, 037
Electrohome	037	Radix	037
Electrophonic	037	Randex	037
Emerex	032	RCA	042, 060
Emerson	000, 002, 037, 043, 061, 121, 184, 278	Realistic	000, 035, 037, 046 047, 048, 104, 240
Fisher	047, 104	Ricoh	034
Fuji	033, 035	Runco	039
Funai	000	Samsung	045, 240
Garrard	000	Sanky	039, 048
GE	035, 060	Sansui	041, 067
Goldstar	037, 038	Sanyo	046, 047, 104, 240
Gradiente	000	Scott	043, 045, 121, 184
Harley Davidson	000	Sears	035, 037, 042, 046, 047, 104
Harman/kardon	038	Sharp	048
Harwood	072	Shintom	072
Headquarter	046	Shogun	240
HI-Q	047	Singer	072
Hitachi	041, 042	Sony	032, 033, 034, 035
Jensen	041	STS	042
JVC	041, 067	Sylvania	000, 035, 043, 081
Kenwood	038, 041, 067	Symphonic	000
KLH	072	Tatung	041
Kodak	035, 037	Teac	000, 041
Lloyd	000	Technics	035, 162
Logik	072	Teknika	000, 035, 037
LXI	037	TMK	240
Magnavox	035, 039, 081	Toshiba	043, 045
Magnin	240	Totevision	037, 240
Marantz	035, 081	Unitech	240
Marta	037	Vector	045
Matsushita	035	Vector Research	038
MEI	035	Video Concepts	045, 061
Memorex	000, 035, 037, 039, 046, 047, 048, 104 240	Videosonic	240
MGA	043, 061	Wards	000, 035, 042, 047, 048, 072, 240
MGN Technology	240	XR-1000	000, 035, 072
Minolta	042	Yamaha	038
Mitsubishi	043, 061, 067	Zenith	033, 034, 039
Motorola	035, 048		

CABLE CONVERTER BOX AND CD PLAYERS

Infrared Codes Index

The Universal Infrared Remote Control is capable of operating many brands of Cable Converter Boxes, and CD Players. Refer to page 29 for programming procedures.

NOTE: The Universal Remote Control memory is limited. Some models of Cable Converter Boxes and CD Players may not operate. The Universal Remote Control is not designed to control all features that are available in all models.

NOTE: After entering the proper infrared code, press the Remote **CBL** Selection Mode button (☆). To operate the Remote Cable function buttons, refer to pages 12 and 13 for Remote Control Key Functions.

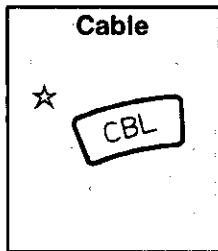

Codes For Cable Converter Box			
Brand of Cable-TV Box	Code(s)	Brand of Cable-TV Box	Code(s)
ABC	003, 007, 008, 011, 013, 014, 017	Pioneer	144, 533
Archer	153	Pulsar	000
Century	153	RCA	021
Citizen	153	Regal	020, 259
Contec	019	Rembrandt	011
Dae Ryung	008	Runco	000
Garrard	153	Samsung	144
Gemini	015	Scientific Atlanta	008, 017, 477
General Instrument	011, 476	Signal	015
Goldstar	144	Signature	011
Hamlin	009, 020, 259	Sprucer	021
Hitachi	011	Starcom	003, 015
Hytex	007	Stargate	015
Jasco	153	Starquest	015
Jerrold	003, 011, 012, 014, 015, 476	Tocom	012, 013
Memorex	000	Toshiba	000
Oak	007, 019	Tusa	015
Panasonic	000, 021, 107	Unika	153
Paragon	000	United Artists	007
Philips	153	United Cable	003
		Universal	153
		Zenith	000, 525

NOTE: After entering the proper infrared code press the Remote **CD** Selection Mode button (☆☆). To operate the Remote CD Player function buttons, refer to pages 12 and 13 for Remote Control Key Functions.

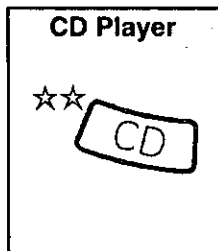

Codes For CD Players			
Brand of CD Players	Code(s)	Brand of CD Players	Code(s)
Aiwa	124, 157	Onkyo	101
CA Audio Lab	029	Optimus	000, 032, 037, 305, 426, 468
Carver	157	Panasonic	029, 367
Denon	003	Philips	157
DKK	000	Pioneer	032, 468
Emerson	305	Proton	157
Fisher	048	QED	157
Genexxa	032, 305	Quasar	029
Harman-Kardon	426	RCA	305
Hitachi	032	Rotel	157
JVC	072	SAE	157
Kenwood	028, 037, 048, 190	Sansui	157, 305
Krell	157	Scott	305
LXI	305	Sears	305
Magnavox	157	Sharp	037
Marantz	029, 157	Sherwood	426
MCS	029	Sony	000
Mission	157	Technics	029, 303
Nakamichi	147	Victor	072
NSM	157		

CASSETTE PLAYERS, RECEIVERS, and AMPLIFIERS

Infrared Codes Index

The Universal Infrared Remote Control is capable of operating many brands of Cassette Players, Receivers, or Amplifiers. Refer to page 29 for programming procedures.

NOTE: The Universal Remote Control memory is limited. Some models of Cassette Players, Receivers, and Amplifiers may not operate. The Universal Remote Control is not designed to control all features that are available in all models.

NOTE: After entering the proper infrared code, press the Remote **AUX** Selection Mode button (*). To operate the Remote Cassette Player function buttons, refer to pages 12 and 13 for Remote Control Key Functions.

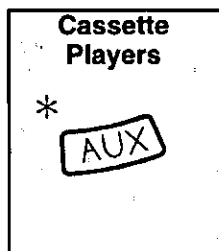

Code Index For Cassette Players			
Brand of Cassette Players	Code(s)	Brand of Cassette Players	Code(s)
Aiwa	029	Panasonic	272
Carver	029	Philips	029
Denon	076	Pioneer	027, 220
Kenwood	070	Sansui	029
Magnavox	029	Sherwood	337, 338
Marantz	029	Sony	170, 243
Nakamichi	147	Technics	229
Optimus	027, 220, 337, 338	Wards	027
		Yamaha	094, 097

NOTE: After entering the proper infrared code, press the Remote **RCVR** Selection Mode button (**). To operate the Remote Receiver or Amplifier function buttons, refer to pages 12 and 13 for Remote Control Key Functions.

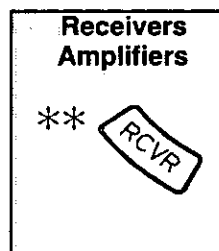

Code Index For Receivers And Amplifiers			
Brand of Receiver / Amplifier	Code(s)	Brand of Receiver / Amplifier	Code(s)
ADC	531	Panasonic	039
Aiwa	121, 158, 189	Penney	195
Carver	008, 042, 189, 269	Philips	189, 269
Casio	195	Pioneer	013, 014, 080, 300, 531
Clarinet	195	Quasar	039
Denon	004	RCA	531
Fisher	042, 219	Realistic	195
JVC	074	Sansui	189, 321
Kenwood	027, 186	Sanyo	219
Lloyd's	195	Sharp	186
Magnavox	189, 195, 269, 531	Sherwood	502
Marantz	039, 189, 269, 321	Sony	158
MCS	039	Technics	039, 208, 308, 309, 518
Modulaire	195	Victor	074
NAD	320	Wards	013, 014, 042, 080, 158, 189
Nakamichi	321, 347	Yamaha	176, 186, 354
Onkyo	135	Yorx	195
Optimus	013, 080, 186, 219, 300, 531		

LASER DISC, DSS (Digital Satellite System), and DVD (Digital Videodisc)

Infrared Codes Index

The Universal Infrared Remote Control is capable of operating selected brands of Laser Disc, DSS Digital Satellite System, and DVD (Digital Videodisc) Refer to page 29 for programming procedures

NOTE: The Universal Remote Control memory is limited Some models of Laser Disc, DSS Digital Satellite System, and DVD (Digital Videodisc) may not operate The Universal Remote Control is not designed to control all features that are available in all models

NOTE: After entering the proper infrared code, press the Remote LD Selection Mode button (○) To operate the Remote Laser Disc function buttons, refer to pages 12 and 13 for Remote Control Key Functions

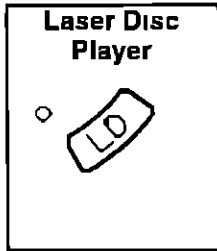

Codes For Laser Disc	
Brand of Laser Disc	Code(s)
Mitsubishi	059
NAD	059
Panasonic	204
Pioneer	059
Quasar	204
Sony	201

NOTE: After entering the proper infrared code, press the Remote DSS Selection Mode button (◊◊) To operate the Remote Satellite function buttons, refer to pages 12 and 13 for Remote Control Key Functions

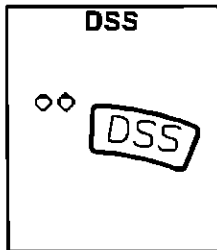

Codes For DSS (Digital Satellite System)	
Brand of Satellite	Code(s)
Panasonic	701
RCA	566
Sony	639

NOTE: After entering the proper infrared code, press the Remote AUX Selection Mode button (★) To operate the Remote DVD (Digital Videodisc) function buttons, refer to pages 12 and 13 for Remote Control Key Functions

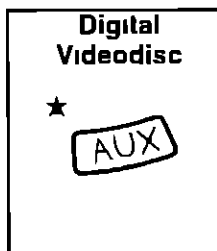

Codes For DVD (Digital Videodisc)	
Brand of DVD	Code(s)
Panasonic	490

Care and Cleaning

Picture Tube (Turn set off)

Use a mild soap solution or window cleaner and a clean cloth DO NOT USE ABRASIVE CLEANERS Avoid excessive moisture and wipe dry

Plastic Cabinets

Wipe the cabinet with a soft cloth dampened with water or a mild detergent solution and wipe dry with a soft clean cloth Avoid excessive moisture Do not use benzene, thinners or other petroleum based cleaners

Wood Cabinets

When dusting or polishing the cabinet, use a clean soft cloth and stroke straight with the grain An occasional coat of furniture polish will help preserve the finish Do not use benzene, thinners or other petroleum based cleaners Do not place objects made of plastic or rubber directly on top of the cabinet A chemical reaction could result causing permanent marring of the finish

Remote Control Transmitter

Do not use benzene, thinners or other petroleum based cleaners to clean the Remote Control Transmitter To clean, wipe with a soft cloth slightly moistened with a mild detergent and then wipe dry with a soft clean cloth

















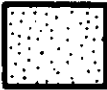

Power Loss

Prolonged power interruption causes the following features to reset to their factory preset state.

FEATURE	FACTORY PRESET STATE	FEATURE	FACTORY PRESET STATE
POWER	OFF	CLOCK	NOT SET
VOLUME	APPROX -1/3	SLEEP TIMER	NO/OFF
CHANNEL	CH 03	TIMER	NO/OFF
PROGRAM MEMORY	UNPROGRAMMED	ANTENNA MODE	CABLE
VIDEO MENUS	NORMALIZED	TV/VIDEO	TV
STEREO/SAP/MONO	STEREO	TRILINGUAL MENU	ENGLISH

Troubleshooting Chart

Before you call for service, determine the symptoms and make a few simple checks shown below.

Symptoms		Check
Picture	Sound	
 SNOWY PICTURE	 NOISY SOUND	- ANTENNA LOCATION AND/OR CONNECTION
 MULTIPLE IMAGE	 NORMAL SOUND	- ANTENNA DIRECTION AND/OR LOCATION - ANTENNA LEAD-IN WIRE
 INTERFERENCE	 NOISY SOUND	- ELECTRICAL APPLIANCES, LIGHTS, CARS AND TRUCKS - DIATHERMY AND OTHER MEDICAL EQUIPMENT
 NORMAL PICTURE	 NO SOUND	- VOLUME CONTROL SETTING - MUTE CONTROL (IF APPLICABLE) - TRY ANOTHER CHANNEL - TV SPEAKERS (IF APPLICABLE) IN THE OFF MODE
 NO VIDEO	 NOISY SOUND	- TV OR CABLE TUNING MODE SET TO PROPER SETTING - ANTENNA INPUT CORRECT (IF APPLICABLE)
 NO PICTURE	 NO SOUND	- CHECK THAT AC POWER LINE IS PLUGGED INTO AC OUTLET - BRIGHTNESS & AUDIO CONTROLS SET PROPERLY - TRY ANOTHER CHANNEL
 NO COLOR	 NORMAL SOUND	- COLOR CONTROL SETTINGS - TRY ANOTHER CHANNEL
 BLUE PICTURE	 NO SOUND	- RECEIVER IN VIDEO MODE WITH NO SIGNAL
 BLACK BOX IN PICTURE	 SOUND	- CC (CLOSED CAPTION) IN TEXT MODE (IF APPLICABLE) - SELECT CAPTION OFF MODE TO ELIMINATE BLACK BOX

Should this unit turn ON momentarily and then turn OFF, or fail to operate, unplug the AC cord and contact your Authorized Servicer for repairs.

**Matsushita Consumer Electronics
Company, Division of Matsushita
Electric Corporation of America**
One Panasonic Way
Secaucus, New Jersey 07094

Matsushita Electric of Canada Limited
5770 Ambler Drive
Mississauga, Ontario L4W 2T3
Canada

**Panasonic Sales Company,
Division of Matsushita Electric
of Puerto Rico Inc ("PSC")**
Ave 65 de Infanteria, Km 9.5
San Gabriel Industrial Park
Carolina, Puerto Rico 00985
Tel (809) 705-4300
FAX (809) 768-2910